



User's Manual



Notes, Cautions, and Warnings



NOTE: A NOTE indicates important information that helps you make better use of your smartphone.



CAUTION: A CAUTION indicates either potential damage to hardware or loss of data and tells you how to avoid the problem.



WARNING: A WARNING indicates a potential for property damage, personal injury, or death.

Information in this document is subject to change without notice.

© 2009 Dell Inc. All rights reserved.

Reproduction of these materials in any manner whatsoever without the written permission of Dell Inc. is strictly forbidden.

Trademarks used in this text: Dell and the DELL logo are trademarks of Dell Inc.; Bluetooth is a registered trademark owned by Bluetooth SIG, Inc. and is used by Dell under license.

Other trademarks and trade names may be used in this document to refer to either the entities claiming the marks and names or their products. Dell Inc. disclaims any proprietary interest in trademarks and trade names other than its own.

Designs, images, and other depictions of products may change from when this publication was produced.

July 2009

Contents

Before You Use Your Smartphone	7	Replacing the SIM Card	15
Safety Warnings	7	Replacing the microSD Card	16
General Statement on RF Energy	8	Mini3i Smartphone Accessories	18
Proper Disposal	8	Mini3i Smartphone Features	20
Setting Up Your Smartphone	9	Front View	20
What You Need.	9	Back View	20
Activate Phone Service	9	Left View	21
Setting Up the Smartphone for the First Time	9	Right view.	22
Maintaining Your Smartphone	13	Status Bar.	23
Charging the Battery	13	Using The Touch Screen.	25
Removing the Battery	14	Entering Text or Numbers	27
Replacing the Battery	14	Selecting Input Methods	27
		Entering Text with Qwerty	28

Contents

Changing the Language	28	Location Settings	42
Entering Numbers and Symbols . .	29	Language Settings	43
Exiting the Input Panel	29	Profile Settings	44
Using FullScreenHandWriting . . .	29		
Using the 4x4 Keyboard	31	Mini3i Smartphone	48
Understanding Sleep Mode.	32	Using the Dialer	48
Understanding Phone Lock	32	Answering an Incoming Call	53
Using the Home Screen	34	Accessing the Call Log.	54
Connecting to the Internet	36	Understanding Call Settings.	55
Selecting Cellular Data Networks .	36	Fixed Dial Number (FDN) list	57
Understanding Phone Basics.	36	Call Barring	58
Display Settings	37	Call Forwarding	59
Date & Time Settings	39	Other Basic Call Settings	60
		Using Speed Dial	61

Editing SMS Messages For Rejected Calls	62	Using the Internet Browser	68
Using Voicemail	62	Go to URL	68
Using The In-call Timer.	63	Zoom In and Zoom Out	70
Understanding Smartphone Settings	63	Window Overview	72
Managing Bluetooth Connections .	63	Bookmarks	72
Understanding Network Settings . .	65	Accessing Browser Options	75
Configuring Mobile Networks . . .	65	Changing Browser Settings.	76
Setting Security Options	66	Using Email Features	78
Managing SD Card and Phone Storage	67	Introducing 139 Mail	78
Using Internet Features	68	Managing Email Accounts	79
Available Monternet Services	68	Adding an Account From 139 Mail, 21cn, or Gmail.	79
		Setting Up and Editing Accounts. . .	80

Contents

Removing an Account	82	Creating a Playlist.	89
Managing Email Messages	82	Managing Playlists	91
Sending Emails	82	Creating Ringtones From Songs	91
Receiving Emails	83	Understanding the Music Player	92
Deleting Messages.	84	Browsing and Playing Videos.	93
Deleting Email Permanently	85	Managing Videos	94
Using Fetion.	85	Using the Video Player	97
Managing Your Fetion Account and Messages.	86	Using the Picture Application.	97
Changing Fetion Settings	87	Browsing Pictures	98
Using My Favorites	88	Managing Picture Files	100
Browsing and Playing Music	88	Changing Picture Settings	102
Managing Music Files	89	Using the Camera.	104
		Camera mode	104
		Using Video Recording Mode.	105

Using the Recorder Application . . .	106	Data Connection	114
Using Applications	107	Service Center	115
Messaging	107	Signature	115
To read unread messages	107	Calendar	116
To reply to a message	107	Calendar Views	116
To send messages to your contacts	107	Using the Calendar	119
To add more to messages	109	Hide declined events	120
To open Folder View	110	Set default view	121
To backup messages	110	Set alerts & notifications	121
To restore data	111	Set default reminder	122
Messaging Settings	112	Alarm Clock	122
Expire Time	113	Calculator	126
Request Read Reports	113	File Manager	126
Auto-retrieval	113		
Auto-retrieval while roaming . . .	114		

Contents

Notes	132	Backup	140
To Do List	135	Restore	141
World Clock	136	DCD	141
Clock setting	138	DCD Settings	142
Applications	138	Connection	142
Program Manager	138	Scrolling	142
Toolbox	138	Read-Items Display	142
Search	138	Close DCD Window	142
Using Search	139	PC Sync Tool	142
Select search preferences	139	Installing PC Sync Application	142
Advanced search	139	Connecting the smart phone	143
Index statistic	140	Using the PC Sync Tool	144
Backup	140	Index	146

Before You Use Your Smartphone

Safety Warnings

Read the following safety warnings carefully before using your cell phone.

- This equipment is intended for use with power supplied from supplied battery charger(s) and/or power supply unit(s). Other usage will invalidate any certification given to this product and may be dangerous.
- Switch off your cell phone when in an aircraft. The use of cellphone in an aircraft may be dangerous to the operation of the aircraft, could disrupt cellular networks, and may be illegal. Failure to observe this instruction may lead to suspension or denial of cell phone services to the offender, legal action, or both.
- Do not use the cell phone or cell phone equipment when at a refueling point or gas station.
- Observe restrictions on the use of radio equipment in fuel depots, gas stations, chemical plants, or where blasting operations are in progress.
- You **MUST** exercise proper control of your vehicle at all times. Observe the following safety precautions when driving:
 - Do not use a hand-held telephone or microphone while you are driving.
 - When driving, find a safe place to stop the vehicle before using the cell phone.
 - Do not speak into a hands-free microphone if it will distract you from driving.

Before You Use Your Smartphone

- You **MUST NOT** stop on the hard shoulder of a motorway to answer or make a call, except in an emergency.



NOTE: In some areas where electric current fluctuates, it is recommended that you plug the charger to an AVR (AC Voltage Regulator) instead of a direct connection to a power outlet. Fluctuation in the electric current may damage the charger and/or the device.

General Statement on RF Energy

Your phone contains a transmitter and a receiver. When it is on, it receives and transmits radio frequency (RF) energy. When you communicate with your phone, the system handling your call controls the power level at which your phone transmits RF energy.

Proper Disposal



The symbol of the crossed out bin indicates that the product (electrical and electronic equipment) should not be placed in municipal waste. Please check local regulations for disposal of electronic products.

Setting Up Your Smartphone

Congratulations on the purchase of your Dell Mini 3i. Please ensure that you read this manual carefully and keep it in a safe place for future reference.

What You Need

To use all of the phone features, you need:

- A wireless service plan with a carrier
- An Internet connection
- A computer with a USB 2.0 port

Activate Phone Service

Before you can use any of the phone features, you must activate the phone. To activate the phone you must:

- Sign up for a service plan with a service carrier in your area
- Register the phone with the network

If you purchased this phone from a service carrier, activation may have been done during the purchase.

Setting Up the Smartphone for the First Time

The phone ships with some components uninstalled (such as the battery and sometimes SIM card). You will need to install these parts and charge the battery before you can use your smartphone.

To set up your phone for the first time:

1 Open the cover.

Slide a finger into the finger slot, then lift and remove the cover.

Setting Up Your Smartphone

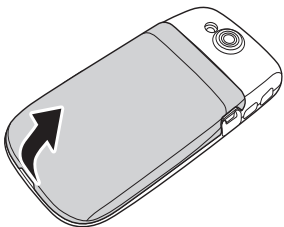

2 Install the SIM card.

- a Rotate the SIM card lock outwards.

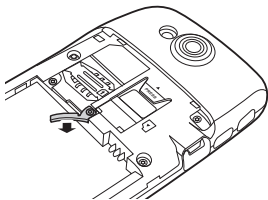

- b Hold the SIM card with the metal contacts facing down and insert the card into the SIM card holder.



NOTE: To ensure proper installation, align the cut corners in the card and the SIM card slot.

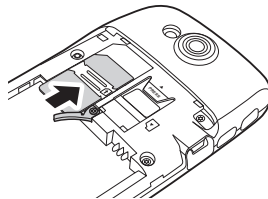

- c** Rotate the SIM card lock back into place to lock the SIM card.

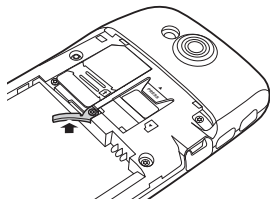

3 Install the microSD card.

- a** Hold the microSD card with the metal contacts facing down.
- b** Slide the microSD card into the microSD card holder.

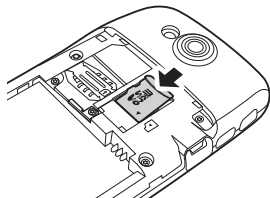

4 Install the battery.

Align the metal contacts on the battery with the contacts on the battery holder and insert the battery.

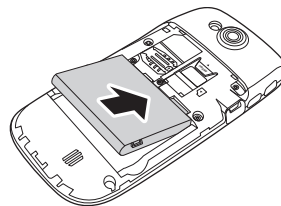

5 Close the cover.

Insert the tabs on the cover into the slots on the phone and snap the cover in place.

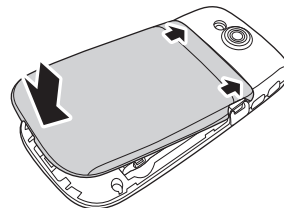

Setting Up Your Smartphone

6 Charge the battery.



CAUTION: Do not use any non-approved chargers as they may damage your phone and invalidate any warranties.



NOTE: It takes at least one charging-discharging cycle for the battery to reach its peak performance.

- a Using the Mini-USB to USB cable, plug the power adapter into a power outlet and then into your phone.

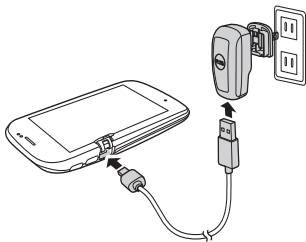

- b Charge your phone for at least 2 hours. Ensure that your phone is fully charged by checking the charge indicator on the status bar.

7 Turn on your phone.

Press and hold the power button for two seconds.

Maintaining Your Smartphone

This section provides information on charging the battery and replacing components (SIM card, microSD card, and battery) in your smartphone.

Charging the Battery



CAUTION: Do not use any non-approved chargers as they may damage your phone and invalidate any warranties.



NOTE: It takes at least one charging-discharging cycle for the battery to reach its peak performance.

- 1 Ensure the battery is installed.

- 2 Using the Mini-USB to USB cable, plug the power adapter into a power outlet and then into your phone.

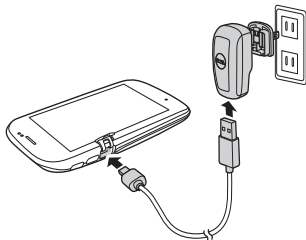

- 3 Charge your phone for 2 hours. Ensure that the phone is fully charged.
- 4 When charging is complete, press the power button for 2 seconds to exit the charge screen.

Removing the Battery

- 1 Slide a finger into the finger slot, and then lift to remove the cover.
- 2 Slide fingers into the finger slots, and then lift to remove the battery.

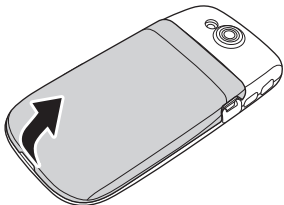

- 3 Slide fingers into the finger slots, and then lift to remove the battery.

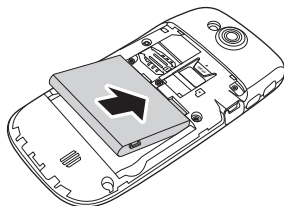

- 2 Close the cover.

Replacing the Battery

- 1 Align the metal contacts on the battery with the contacts on the battery holder and insert the battery.

Replacing the SIM Card

- 1 Slide a finger into the finger slot, and then lift to remove the cover.

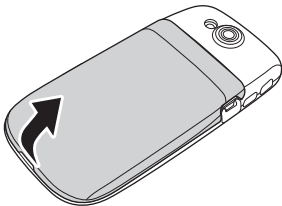

- 2 Remove the battery from the battery holder (see "Removing the battery" on page 14).

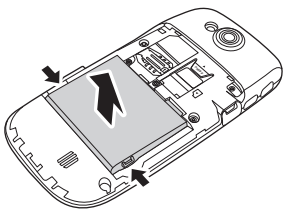

- 3 Rotate the SIM card lock outwards to release the lock and then slide the SIM card out of the SIM card holder.

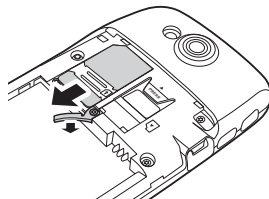

- 4 Hold the SIM card with the metal contacts facing down and insert the card into the SIM card holder.



NOTE: To ensure proper installation, align the cut corners in the card and the SIM card slot.

Maintaining Your Smartphone

- 5 Insert the SIM card into the SIM card holder. Make sure it goes in completely.

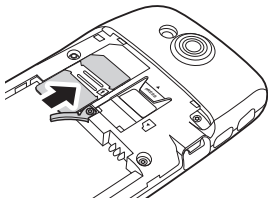

- 6 Rotate the SIM card lock back into place to lock the SIM card.

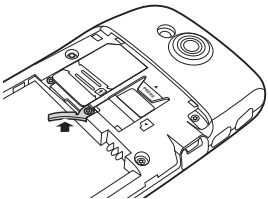

- 7 Close the cover.

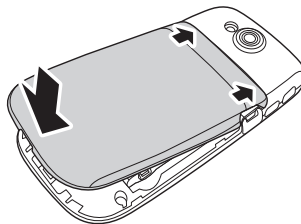

Replacing the microSD Card

- 1 Slide a finger into the finger slot, and then lift to remove the cover.

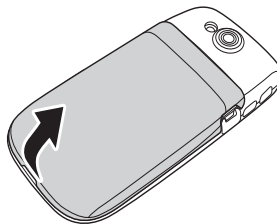

- 2 Press down on the release tab at the top of the microSD card holder, and then slide the microSD card out.

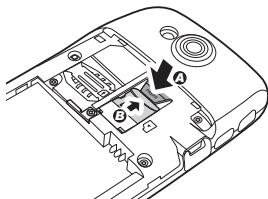

- 3 Hold the microSD card with the metal contacts facing down.
- 4 Slide the microSD card into the microSD card holder. Ensure that the microSD card goes in completely

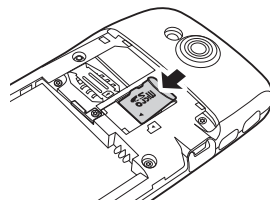

- 5 Close the cover.

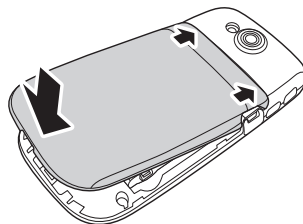

Mini3i Smartphone Accessories

Your smartphone may ship with the following accessories:

- **Mini-USB headset** — allows you to listen to music or a phone conversation. Callers hear you through the integrated microphone. To use the headset, connect it to the Mini-USB port (see “Left View” on page 21).
- **Stylus** — allows you to quickly enter text using the on-screen keyboards and handwriting tools (see “Selecting Input Methods” on page 27).

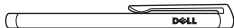

- **USB to Mini-USB data cable** — allows you to connect your smartphone to a computer for file transfers and data synchronization (see “PC Sync Tool” on page 142).

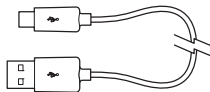

NOTE: The USB to Mini-USB cable is also used to connect to the power adapter to charge the battery.

- **Power adapter** — use to charge the battery (see “Charging the Battery” on page 13).

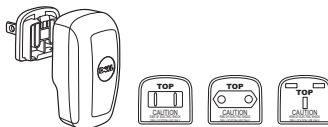



NOTE: The type(s) and number of the power adapter plug head(s) that shipped with your smartphone may vary depending on the country where you purchased the phone.

- **Microfiber pouch** — allows you to store the phone for protection when not in use, and to clean the screen as needed.

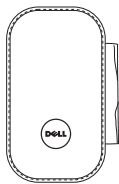

CAUTION: Do Not use solvents, water, or other liquids to clean your smartphone. The included pouch is designed to be used dry. Liquids may damage your smartphone and invalidate any warranties.

Mini3i Smartphone Features

Front View

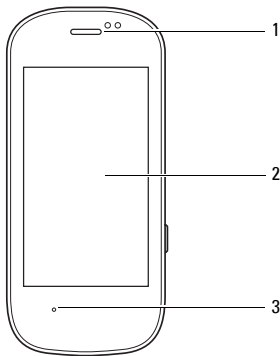

- 1 **Speaker** — Use to listen to phone conversations.
- 2 **LCD Panel** — Displays phone images.
- 3 **Microphone** — Use for voice calls.

Back View

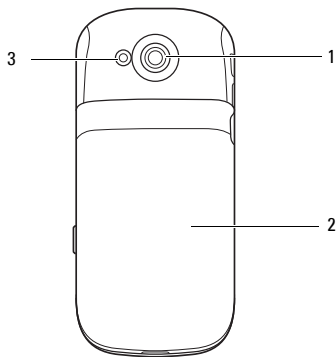

- 1 **Camera** — Use to take photos and capture video.
- 2 **Cover** — Covers the battery, SIM card, and microSD card holders.
- 3 **Camera flash** — Use to take photos in dim light.

Left View

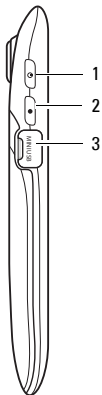

- 1 Power/Lock button** — Short press (when the display is active): locks or unlocks the display. Short press (when the display is in sleep mode): wakes up the display. Long Press: PowerOn/Power Off.
- 2 Home/Back button** — Short press: navigate back one screen at a time. Long press: return to the Home screen.
- 3 Mini-USB Port** — Use to charge the phone, connect to a computer, or connect to a headset.

Right view

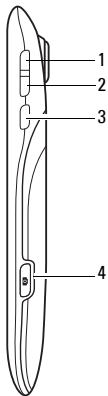

- 1 Volume up** — Press to increase the volume level.
- 2 Volume down** — Press to decrease the volume level.
- 3 Options button** — Short press to open the Options menu.
- 4 Camera button** — Press to activate the camera and take photos or capture video.











Status Bar













The status bar appears at the top of the screen. Icons appear on the status bar to notify you of a new message, upcoming calendar event, alarm, or other information important to you.







The following table outlines status icons:

Status Icons

Icon	Information
	New email
	New SMS or MMS
	New instant message
	New voicemail
	Alarm is set
	GPS is enabled
	GPS is connected
	Sync
	Sync error
	Outgoing call

Mini3i Smartphone Features

Icon	Information
	Missed call
	Incoming call
	Call forwarding is active
	Speakerphone is on
	Microphone is on mute
	Silent mode
	Vibrate mode
	USB is connected
	Bluetooth is connected
	Bluetooth is enabled

Icon	Information
	Battery charge is full
	Battery charge is 20%
	Battery is charging
	Full signal strength
	Half signal strength
	No signal
	microSD card is installed

Using The Touch Screen



This section provides instructions to use the touch screen.

- Selection** — To select an item or open an application, tap the item or application with your fingertip.

To go back to the previous screen, tap the **Back** icon.

To go back to the home screen, tap the **Home** icon.



-  Home icon
-  Back icon
-  Options panel

Mini3i Smartphone Features

- **Options panel** — Provides additional options for the currently selected application. Tap and hold an option for a second, and then release to view a pop-up menu of the available functions.
- **Pop-up menu** — Lists the functions available for the currently selected application. You can scroll up or down within the menu of all the available functions are not visible on the screen.
- **Zoom in/Zoom out** — To zoom in or out on the current screen, use the zoom icons of the program you are using.



NOTE: In Browser and Picture Viewer modes, multi touch is enabled to enlarge or minimize the images on the screen.

- **Drag items** —



To move an item on the screen, tap and drag the item to the desired position.

- **Scroll up or down** —



To scroll up or down in a list or on a page on the screen, slide your finger up or down on the screen.

- **Scroll right/left** —



To scroll right or left in a menu or to go back to the previous menu, slide your finger to the right or left on the screen.

Entering Text or Numbers

When you start a program or select a field that requires text or numbers, the input panel appears automatically. You can select an input method and start inputting the text. The phone may automatically suggest vocabularies or commonly used phrases as you enter text.



Your phone supports inputs in multiple languages, and provides the following input methods:

- Qwerty
- FullScreenHandWriting
- 4x4KeyBoard

Selecting Input Methods

- 1 Tap a text field, such as in a note or new contact, to open the input panel.
- 2 Tap the **Switch Input Method** icon to open the Switch Input Method screen.
- 3 Tap the input method you prefer.



- 1 Input panel
- 2 Switch Input Method icon
 -  Keyboard
 -  Full screen handwriting
 -  4 x 4 Keyboard

Entering Text with Qwerty

As you type, each letter appears above your thumb or finger. The letter is not entered until you release your finger from the key.

- 1 Tap a text field, such as in a note or new contact, to open the input panel.
- 2 Tap the **Switch Input Method** icon and select **Qwerty** as your input method.

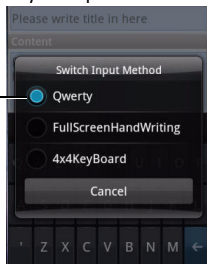

- 1 Switch Input Method menu

- 3 Tap keys on the keyboard to enter text.

Changing the Language

Tap the **Language** icon to switch between English and Simplified Chinese.

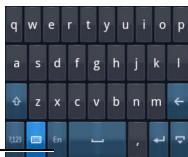

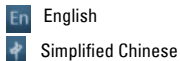

- 1 Language icons

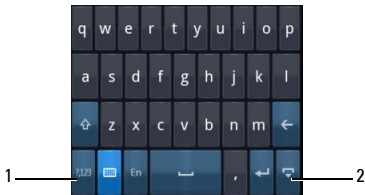

Entering Numbers and Symbols

Tap the **Numbers and Symbols** icon to change the input to numbers and symbols.



- 1  Numbers and Symbols icon
- 2  Exit icon

Exiting the Input Panel

Tap the **Exit** icon to exit the input panel.

Using FullScreenHandWriting

FullscreenHandwriting allows you to write across the entire screen.

- 1 Tap a text field, such as in a note or new contact, to open the input panel.
- 2 Tap the **Switch Input Method** icon and select **FullScreenHandWriting** as your input method.
- 3 Use a stylus or your finger to write anywhere on the screen. The handwriting will be converted to text shortly after you lift the stylus or your finger from the screen.

Mini3i Smartphone Features

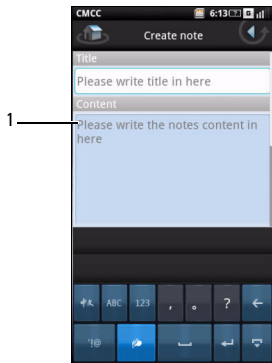

1 Screen



Switch Input Method icons



Tap the **Language** icon to switch between English and Simplified Chinese.



Tap the **Numbers and Symbols** icon to change the input to numbers and symbols.



Tap the **Exit** icon to exit the input panel.

Using the 4x4 Keyboard

In the 4x4Keyboard, you can either enter text by entering letters similar to texting on a numeric keypad.

- 1 Tap a text field, such as in a note or new contact, to bring up the input panel.
- 2 Tap the **Switch Input Method** icon and select **4x4Keyboard** as your input method.
- 3 Use a stylus or your finger to touch a key on the keypad. Characters, numbers, or symbols appear around the keyboard.



- 1 Text for the selected key appears in the highlighted area
- 4 Continue touching the key to toggle different characters, numbers, or symbols.
- 5 Tap the desired character, number or symbol to insert it immediately.
- 6 Tap the **Exit** icon to exit the input panel.

Understanding Sleep Mode

After a period of inactivity, your screen will go to sleep (no image appears on the display). In sleep mode, your phone uses lesser battery power.

Waking up the phone

To wake up the phone, press the **Power On/Off** or the **Back/Home** button.

Understanding Phone Lock

While not on a call, you can lock your control buttons and the screen for security and to avoid accidental touch activation.

Locking the phone

- 1 Tap the **Settings** icon on from the Home screen and then tap **Security, Phone Lock Settings** to open **Phone Lock Settings** screen.
- 2 Enable the Phone lock function by checking the Phone lock checkbox.
- 3 Enter a 4-8 digits phone lock password.

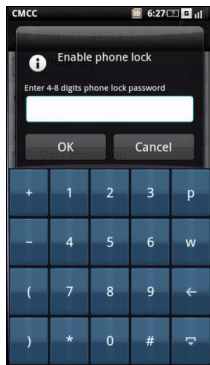

- 4 Tap **OK** to save and exit to the previous screen.
- 5 Select **Lock now** to lock your phone.









Unlocking the phone















- 1 Enter the 4-8 digits phone lock password.
- 2 Tap **Unlock** to unlock your phone.

Using the Home Screen

The Home screen provides you access to all of the applications available on your phone. The following applications are available on your phone:

Applications	Descriptions
 Mobile Music	Provides a rich mobile music experience with playlist management for both online music and local music.
 Fetion	Send free messages to friends, enjoy low charge voice group chatting and file interchange between cell phones and computers.
 139Mail	139Mail allows you to use your phone number as an email account to send and receive messages via Internet, SMS, MMS, or WAP mobile Internet access.
 Monternet	Provides links to portals for sports, entertainment, news, ringtones, games, images, video, and so on.
 Browser	Used to access the World Wide Web.
 Settings	Set up connections, networks, basic functions, and applications.
 Dialer	Make calls and access recent callers and all your contacts. Or dial manually using the numeric keypad.
 Messaging	Send and receive SMS text messages.

Applications**Descriptions**

 Calendar	Set alerts to remind you of events, appointments, and deadlines.
 Contacts	View, search, add, change, or delete contacts.
 My Favorites	Includes Music, Videos, Pictures, Magic Box and other files
 Sound recorder	Allows you to record audio.
 Alarm	Set up, add or delete alarms.
 Calculator	Allows you to perform simple calculation.
 File Manager	Access, use, and manage the files on the phone or the MicroSD card.
 Notes	Allows you to record notes.
 To Do List	Time management program that allows you to add time, date, priority, and status to your tasks.
 World Clock	View the time in cities around the world by adding clocks of your favorite cities.
 Search	Search for contents on the phone or the SIM card.
 Backup	Back up the data on your phone so you can restore the original data after a data loss.
 Applications	Includes Program Manager and Tool Box applications.

Moving Items On the Home Screen

- 1 To move an item from your Home screen, touch and hold the item until the delete icon appears.



- 1 **Delete** icon
- 2 Hold and drag the item to its new location.

Remove items from the Home screen

- 1 To remove an item from your Home screen, touch and hold the item until the delete icon appears.
- 2 Tap the delete icon to remove the selected item.

Connecting to the Internet

Your phone connects to the Internet using a cellular data network.

Selecting Cellular Data Networks

You may connect to the Internet through EDGE or GPRS networks. Check the carrier's network coverage in your area for availability.

Understanding Phone Basics

This section provides information about changing the basic settings on your phone.

Tap the **Settings** icon on the Home page to open the **Settings** screen.



Display Settings

Display settings allow you to adjust the screen brightness, screen timeout, and screen lock settings.

To enable the auto brightness:

- 1 In the Home screen, tap the **Settings** icon on the Home page to open the Settings screen.

- 2 In the Phone basics section, tap **Display Settings** to open the **Display Settings** screen.



- 3 In the Brightness settings section, tap the **Auto Brightness** check box to enable auto brightness.

To set brightness manually:

- 1 In the Home screen, tap the **Settings** icon on the Home screen to open the Settings screen.
- 2 In the Phone basics section, tap **Display settings** to open the Display settings screen.
- 3 In the Brightness settings section, tap **Brightness** to open the Brightness panel.

 **NOTE:** Ensure that the Auto Brightness check box is not selected

- 4 Use your finger or stylus to move the slider on the Brightness panel to the left or right to adjust the brightness.

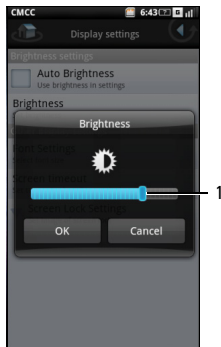

1 Slider

- 5 Tap **OK** to save and exit the **Brightness** panel.

To set up screen time out:

- 1 In the Home screen, tap the **Settings** icon on the Home screen to open the Settings screen.
- 2 In the Phone basics section, tap **Display settings** to open the Display settings screen.
- 3 In the Other Display settings section, tap **Screen timeout** to open the Screen timeout panel.

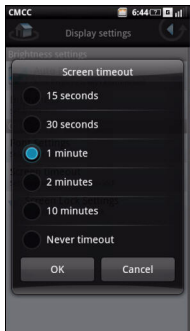

- 4 Tap the time you wish the phone to turn off the screen after idle. The available options are **15 seconds, 30 seconds, 1 minute, 2 minutes, 10 minutes** and **Never timeout**.
- 5 Tap **OK** to save and exit the **Screen timeout** panel.

Date & Time Settings

Date and time settings allow you to set date, time, time zone, and formats.

To set date:

- 1 In the Home screen, tap the **Settings** icon to open the Settings screen.
- 2 In the Phone basics section, tap **Date & time settings** to open the Date & time settings screen.

- 3 In the Set Date and Time section, tap **Set date** to open the Change date panel.

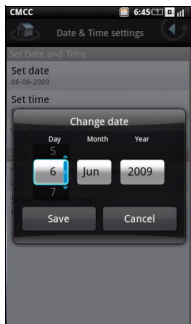

- 4 Slide your finger up or down on each field to change the date, month, or year.
- 5 Tap **Save** to save your changes and exit the **Change date** panel.

To set time zone:

- 1 In the Home screen, tap the **Settings** icon on the Home screen to open the Settings screen.

- 2 In the Phone basics section, tap **Date & time settings** to open the Date & time settings screen.
- 3 In the Set Date and Time section, tap **Set time zone** to open the Set time zone screen.
- 4 Slide your finger up or down on the screen to view the entire country/time zone list.
- 5 Tap the time zone you desire to select the time zone.

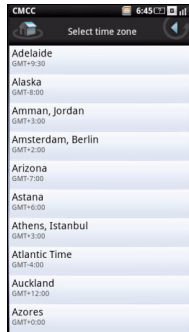

To set time:

- 1 In the Home screen, tap the **Settings** icon on the Home screen to open the Settings screen.
- 2 In the Phone basics section, tap **Date & time settings** to open the Date & time settings screen.
- 3 In the Set Date and Time section, tap **Set time** to open the Change time panel.
- 4 Slide your finger up or down on the hour and the minute fields to change the time and am or pm field.

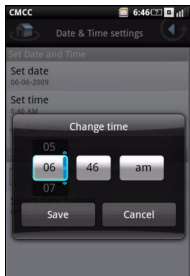

- 5 Tap **Save** to save your changes and exit the Change time panel.

To use the 24-hour format:

- 1 In the Home screen, tap the **Settings** icon on the Home screen to open the Settings screen.
- 2 In the Phone basics section, tap **Date & time settings** to open the Date & time settings screen.
- 3 Tap to select the **Use 24-hour format** checkbox to use 24-hour format.

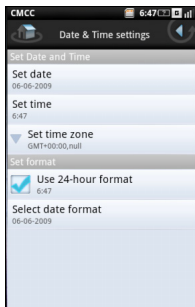

Select date format:

- 1 In the Home screen, tap the **Settings** icon on the Home screen to open the Settings screen.
- 2 In the **Phone Basics** section, tap **Date & time settings** to open the Date & time settings screen.
- 3 Tap **Select date format** to open the **Select date format** panel.
- 4 Tap the date format you prefer from the list.

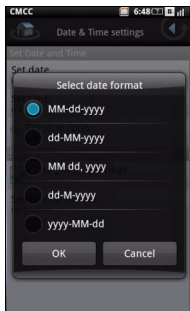

- 5 Tap **OK** to save and exit the **Select Date Format** panel.

Location Settings

Select sources for determining location.

To set location:

- 1 In the Home screen, tap the **Settings** icon on the Home screen to open the Settings screen.
- 2 In the Phone basics section, tap **My Location** to open the **My Location** screen.
- 3 Tap to select the appropriate check boxes to turn on the mobile networks or GPS satellites.

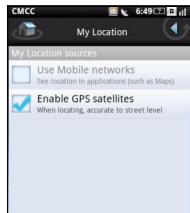

Language Settings

To select the language to display:

- 1 In the Home screen, tap the **Settings** icon to open the Settings screen.
- 2 In the Phone basics section, tap **Language, Select Language** to open the Language screen.
- 3 Tap **Select language** to select the language you prefer from the list including English or Simplified Chinese. The screen exits automatically after your selection.



To activate the input methods:

- 1 In the Home screen, tap the **Settings** icon to open the Settings screen.
- 2 In the Phone basics section, tap **Language** to open the Language screen.
- 3 Tap **Input methods** to open the **Input methods** screen.
- 4 Tap the checkboxes to check the input methods you want to activate.

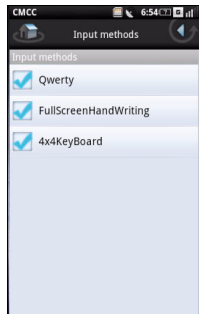

- 5 Tap the **Back** icon to save and exit the Input methods screen.

Profile Settings

You can use profile settings to set your phone to certain preset configurations.

To select a profile to use:

- 1 In the Home screen, tap the **Settings** icon on the Home screen to open the Settings screen.
- 2 In the **Phone Basics** section, tap **Profiles** to open the **Profiles** screen. The **Profile** icon appears next to the selected profile. Profiles include Normal, Vibrate, Silent, Meeting, Airplane mode, and Sleeping.

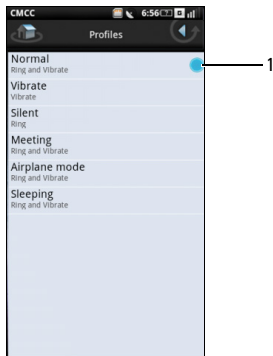

- 1  Profile icon
- 3 Tap the profile you prefer to enter the **Edit Profile** screen.

- 4 You may set up the individual settings by tapping the options on the menu including **Alert Style, Volume, Ringtone, Message Alert, Email Alert, Calendar Alert, Alarm Alert, Reminder Alert, and Fetion Alert.**

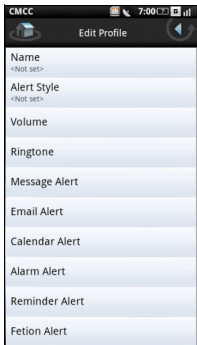

- 5 Press the **Options** button on the phone to open the **Options** panel at the bottom.

- 6 In the **Options** panel, tap **Select** to activate the selected profile and exit the screen.

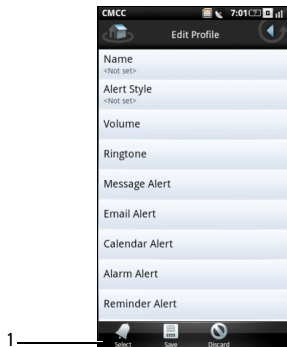

- 1 Options panel

To set up profiles:

- 1 In the Home screen, tap the **Settings** icon on the Home screen to open the **Settings** screen.
- 2 In the **Phone Basics** section, tap **Profiles** to open the Profiles screen.
- 3 Tap the profile you want to set up to enter the **Edit Profile** screen.
- 4 Set up alert style, volume, and ring tones for different events by tapping an option from the list.
 - **Alert Style** — Tap **Ring**, **Vibrate**, or **Ring and Vibrate** on the **Alert Style** panel to change the alert style and tap **OK** to exit.

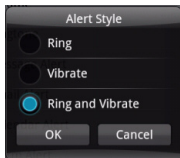

- **Volume** — Slide your finger to the right or left on the screen to increase or decrease the volume level and tap **OK** to close the Volume screen.

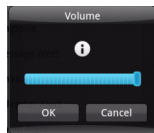

- **Ringtone** — Tap **Message Alert, Email Alert, Calendar Alert, Alarm Alert, Reminder Alert,** or **Fetion Alert** from the Edit Profile screen to open **Select a ringtone screen**. Tap the ringtone you prefer to select it and tap **OK** to exit.

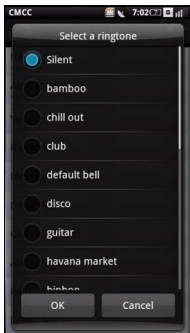

Mini3i Smartphone

To make calls using your phone, tap a contact in the contact list or recent caller list. You can also make calls by using the on-screen dial pad.

Using the Dialer

To dial a number using the on-screen dialer:

- 1 In the Home screen, tap the **Dialer** to open the Dialer screen.

- 2 Tap the **Dialer** tab at the top of the Dialer screen to open the on-screen dial pad.



1	Call log tab
2	Dialer tab
3	← Backspace icon
4	On-screen dial pad
5	📞 Dialer icon

- 3 Touch the on-screen dial pad to enter a number. Use the **Backspace** icon to make corrections.

As you dial the numbers, the phone automatically matches the numbers already stored in your Contacts list. Both the number you are dialing and the potential matches appear on the screen. If you see a match, you can tap it to place the call.

If you do not find a match, finish dialing the number and then tap the **Dialer** icon to dial the number you entered.

To use the other features on your phone while you are on a call, tap the **Back** icon to clear the dial pad.

The **Ongoing call** icon is displayed on top of the Home screen during your phone call.

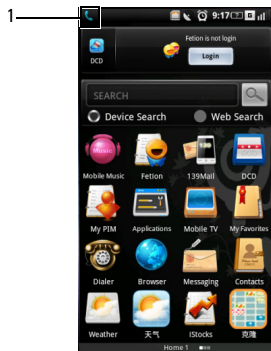

- 1  Ongoing call icon

To end a call:

- 1 Pull down the **Ongoing call** panel and click the **Ongoing call** icon to return to the **In call** screen.
- 2 Slide the **In call** panel down as shown to end the phone call.



NOTE: Placing a new phone call before ending the current call will cause your current phone call to be placed on hold.

To dial a number using the call log:

- 1 In the Home screen, tap the **Dialer** to open the Dialer screen.
- 2 Tap the **Call log** tab at the top of the Dialer screen to open the Call log screen.

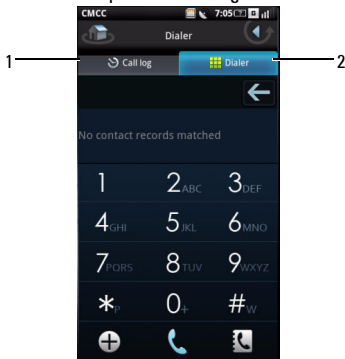

- 1 **Call log** tab
- 2 **Dialer** tab

- 3 Tap a contact from the log to dial the number directly.

To look up a contact from your phone book:

- 1 In the Home screen, tap the **Dialer** to open the Dialer screen.
- 2 Tap the **Dialer** tab at the top of the Dialer screen to open the on screen dial pad.
- 3 Tap the **Phonebook** icon on the Dialer to open the Contacts panel.

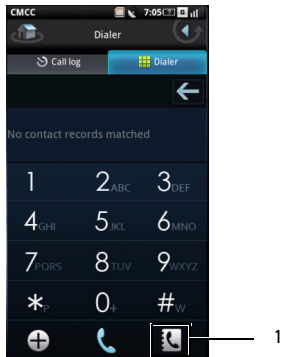

- 1  Phonebook icon

To add new contacts:

- 1 In the Home screen, tap the **Dialer** to open the Dialer screen.
- 2 Tap the **Dialer** tab at the top of the Dialer screen to open the on screen dial pad.



- 3 Tap the **New Contact** icon on the Dialer to open the **New contacts** screen.



- 1  **New Contact** icon
2 **Dialer** tab

- 4 Enter the contact information and add a new field for the contact.
Tap the **More Info** icon to add more information.
Tap the **Delete** icon to delete a field.



- 1  **Delete** icon
 **More info** icon
- 2 Options panel
- 5 Press the Options button on the phone to open the Options panel at the bottom of the screen.
- 6 In the Options panel, tap **Save** to save your contact information and exit, **Discard changes** to exit without saving, or **More Info** to add new data fields.

Answering an Incoming Call

To answer a call, slide up the slider panel on the screen to receive (ANSWER) the call or slide the bar downwards to reject the call. To silence the ringtone or alert, press the volume key on the side of the phone.

Accessing the Call Log

- 1 In the Home screen, tap the **Dialer** to open the Dialer screen.
- 2 Tap the **Call log** tab at the top of the Dialer screen to open the on-screen dial pad. The call log lists all incoming and outgoing calls, including missed calls.



- 1 **Call log** tab

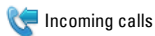

Incoming calls

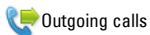

Outgoing calls



Missed calls

To sort or delete entries from the call log, press the Options button and tap the required item on the Options panel that appears at the bottom of the screen.

Sending SMS/MMS

- 1 Select an entry to open the detailed Call log screen.
- 2 Press the Options button to open the Options panel.

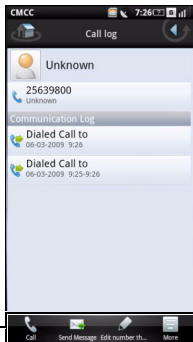

- 1 Options panel

- 3 Tap **Send SMS/MMS** to send SMS/MMS to the contact.

Understanding Call Settings

The following options are available from the Call settings screen:

- Fixed Dial Number list (see “Fixed Dial Number (FDN) list” on page 57)
- Call-Barring (see “Call Barring” on page 58)
- Call forwarding (see “Call Forwarding” on page 59)
- Other basic settings (see “Other Basic Call Settings” on page 60)
- Speed dial (see “Using Speed Dial” on page 61)
- Reject call with SMS (see “Editing SMS Messages For Rejected Calls” on page 62)
- Voicemail (see “Using Voicemail” on page 62)
- In-call timer (see “Using The In-call Timer” on page 63)

To edit your call settings:

- 1 In the Home screen, tap the **Settings** icon on the Home screen to open the Settings screen.
- 2 In the Settings screen, tap **Call settings** to open the Call settings screen.
- 3 Tap the appropriate setting that you want to change.

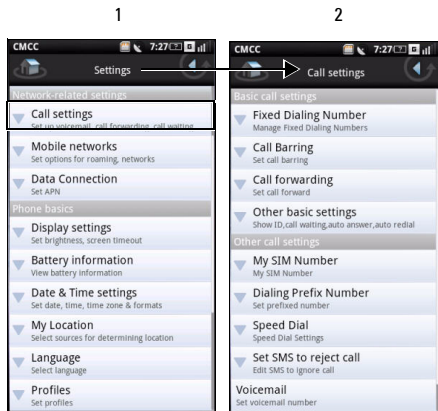

1 Settings screen

2 Call settings screen

- 4 To exit the screen tap the **Back** icon.

See the following sections for more information on each Call setting option.

Fixed Dial Number (FDN) list

The Fixed Dial Number list allows you to restrict outgoing calls from your phone to a restricted list of numbers. To enable this feature, you must know the SIM PIN2 code for your phone. You can get this number from your cellular operator, provided this feature is supported.

To manage the FDN list:

- 1 In the Fixed Dialing Number screen, tap **FDN is disabled**. Type in your PIN2 number to enable FDN feature.

- 2 Select **Manage FDN list**. If you have numbers on your SIM card you can select numbers from it. If not, you will be able to add contacts or numbers to your list.

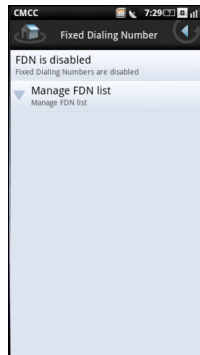

- 3 To add new numbers, Select **Add**, Type the name and number of the contact and then select **Save**. Your FDN list now contains the newly added contact.

Mini3i Smartphone

- 4 Continue adding numbers until you have all the contacts you wish to include on the FDN list.
You may also edit or delete contacts at any time.
- 5 To disable FDN functionality, reselect the **FDN Enabled** option. This changes the FDN status to **FDN Disabled**.

Call Barring

The call-barring screen allows you to enable or disable a function to bar outgoing or incoming calls from a specific number or contact by using a password that you set.

To enable or disable the call barring functions, tap the option on the screen that you would like to set up.

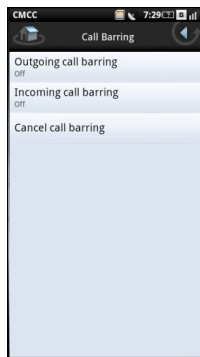

To exit the Call barring screen, tap the **Back** icon.

Call Forwarding

The Call forwarding option allows you to forward calls directly to voicemail.

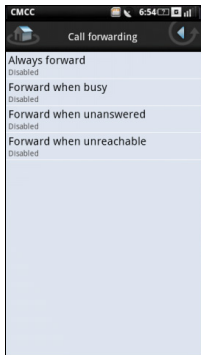

The following options are available when setting up call forwarding:

- **Always forward** — Select to specify a forwarding number and to enable this feature. When this feature is enabled, the Forward when busy, Forward when unanswered, and Forward when unreachable features are disabled.
- **Forward when busy** — Select to enable this feature. When enabled, incoming calls are forwarded to voicemail when you are on a call.
- **Forward when unanswered** — Select to enable this feature. When enabled, incoming calls are forwarded to voicemail when unanswered.
- **Forward when unreachable** — Select to enable this feature. When enabled, calls are forwarded to voicemail if an incoming call cannot connect.

To exit this screen tap the **Back** icon.

Other Basic Call Settings

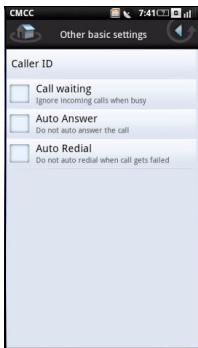

The following options are available from the **Other basic settings** screen:

- **Caller ID** — Select this check box to hide or show your number to recipient's of your call. When your number shows, your phone number and Caller ID picture will appear to people you call, provided the call recipient's device supports this feature.
- **Call waiting** — Select this check box to display incoming calls when you are on a call. Clear the check box to ignore incoming calls when you are already on a call.
 - ✎ **NOTE:** When call waiting is set to ignore incoming calls, routing of the ignored call is determined by your Call forwarding settings.
- **Auto Answer** — Select this check box to answer incoming calls automatically without performing any action.
- **Auto Redial** — Select this check box to auto redial when making a call failed the first time.

To exit this screen tap the **Back** icon.

Using Speed Dial

The Speed dialing option allows you to set up your most frequently used numbers for quick dialing.

To set up Speed dialing:

Tap the Speed Dial number (1 to 9), and enter the phone number for the speed dial. Press the Options button and tap **Save** to save the number.

To use Speed dialing:

Open **Dialer** from the Home screen and tap and hold the Speed dial number. For example, tap and hold **1** to call Speed dial #1.

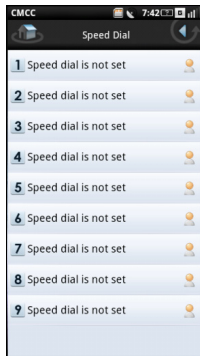

To exit this screen tap the **Back** icon.

Editing SMS Messages For Rejected Calls

This feature allows you to edit a message that will automatically be sent to the caller after you have rejected their call.

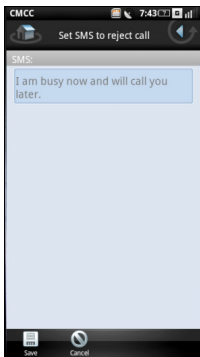

To save your message tap the **Save** icon.
To exit this screen tap the **Back** icon.

Using Voicemail

Your Voicemail number is set by your cellular operator and is stored on your SIM card. Use the Voicemail option to view your voicemail number.

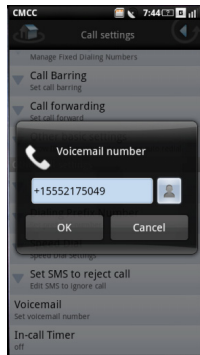

When you have completed using the voicemail option, tap **OK** to save and exit the screen.

Using The In-call Timer

The in-call timer option allows you to monitor the duration of your calls. You can set the timer to 30, 60, 90, or 120 seconds. You can also use this option to enable or disable the in-call timer function.

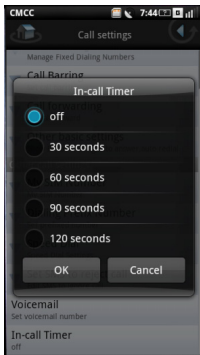

When you have completed setting the time for the in-call timer function, tap **OK** to save and exit the screen.

Understanding Smartphone Settings

Settings allows you to configure your network connection, phone settings, applications, and other preferences.

To open Settings, select **Settings** from the Home screen.

Managing Bluetooth Connections

Bluetooth[®] is a short-range wireless communication technology. Using Bluetooth technology, devices within a 10 meter range can exchange information without requiring a physical connection.

Changing Bluetooth Settings

Select the Bluetooth check box on the Settings screen to turn on Bluetooth.

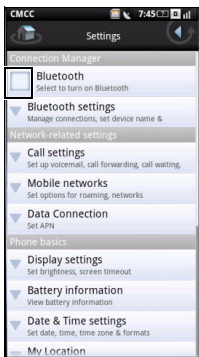

Select this setting to manage connections, and set device name.

Pairing with Bluetooth devices

- 1 Ensure that Bluetooth is enabled before beginning to pair with another device.

- 2 Select the Bluetooth device listed in Bluetooth devices to initiate a connection.
- 3 You might be prompted to enter a passkey to authenticate. Enter the same passkey on both devices, or enter the specific one provided by the device manufacturer.

Changing Data Connection Settings

Select this setting to set your default data connection for multimedia.

To add a new data connection:

- 1 Select "New" to create Browser session over 2G.
- 2 Fill in required fields with provisioning data from your carrier including Name the session, Enter the APN, Set Type to, Proxy, and Port.
- 3 Tap **Save** to save the session.

Understanding Network Settings

The Network settings enable you to set options for roaming and networks.

Configuring Mobile Networks

- **Current Network** — Select this setting to view your current network.
- **Operator Selection** — Use this setting to select a network operator.
- **Search Mode** — Select this setting to set the search mode to manual or auto.

- **Preferred Networks** — Select this setting to set network preferences.

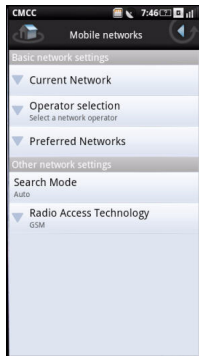

Setting Security Options

Using SIM Card Lock

Select this setting to open SIM Card lock settings where you can enable the SIM Card lock and change your pin code.

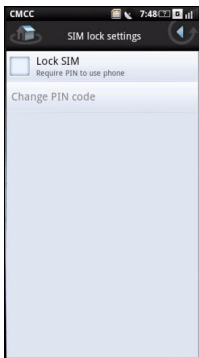

- **Lock SIM card** — Select this check box to lock your SIM card.

- **Change PIN code** — Select this setting to change your SIM card PIN code.

Phone Lock Setting

- Select this setting to open Phone Lock Setting where you can turn on Phone lock and change your password.



- **Phone lock** — Select this check box to turn on the phone lock.

- **Change Password** — Select this setting to change the password for your phone.
- **Data protection** — Select this setting to turn on data protection.

Managing SD Card and Phone Storage

Select this setting to view storage information such as **Total space**, **Available space**, and **Unmount/eject SD card** for your phone and SD card.

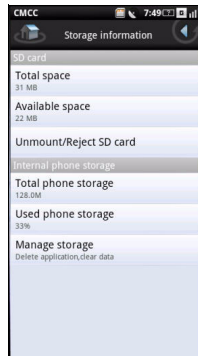

Using Internet Features

Available Monternet Services

From the Home screen, tap **Monternet** to open the Monternet portals.

Monternet services include:

- China Mobile's wireless data business applications
- Unified messaging services
- Service providers (SP) business cooperation
- Corporate wireless network business applications
- Mobile commerce
- Development of mobile Internet technologies such as wireless-related content

Using the Internet Browser

The Options panel and on-screen tools enhance your browsing experience by making it faster, and easier to find Internet content.

From the Home screen, tap the **Browser** icon to open the Browser screen.



Go to URL

- 1 Open the Browser screen and press the **Options** button to open the Options panel.

- 2 Tap the **Go to URL** icon on the Options panel to open the Go to URL screen.



- 1 **Go to URL** icon
- 2 **Options** panel

- 3 Select a URL from the list or tap the **Search on Internet** dialog box to type in the URL manually.
- 4 Possible matches appear on a list of links as you type. Select a match or continue typing the URL.
- 5 Tap the **Go** icon to follow the link to the selected address.



- 1 **Search on Internet** dialog box
- 2 **Go** icon

Zoom In and Zoom Out

Tap and drag the screen to open the magnifier tools.

Use the **Zoom In** icon to zoom in on the web page.

Use the **Zoom Out** icon to zoom out on the web page.



NOTE: Multi touch is enabled to enlarge or minimize the images on the screen.

Use the Selection tool to select an area of the web page to zoom in on.

- 1 **Zoom In** icon
- 2 **Zoom Out** icon
- 3 **Selection tool**
- 4 **Back** icon

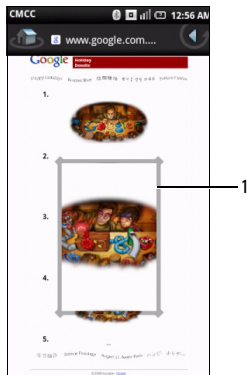

- 1 **Selected area**

To exit this screen tap the **Back** icon.

Window Overview

Window overview allows you to open and manage multiple web pages.

- 1 Press the **Options** button to access the Window overview option.
- 2 Tap **New Window** to open new web pages.

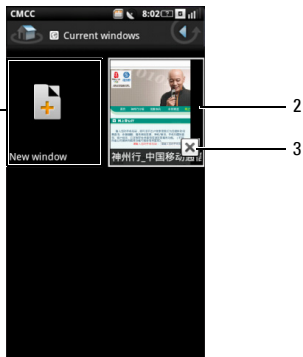

- 1 **New window** icon
- 2 **Web page**
- 3 Close button
- 3 Tap a window to view the opened web page.
- 4 Tap the **Close** button to close opened pages.

Bookmarks

You can store your favorite web pages as bookmarks on the phone.

To view bookmarks:

- 1 Open the Browser screen and press the Options button to open the Options panel.
- 2 Tap **More** and then tap **Bookmarks** on the Options panel to open the Bookmarks screen.

Bookmarks are separated by categories including My favorites, News, and Sports. You can also add new categories.



- 3 Tap a category to view saved bookmarks. Bookmarks are organized in the order of when they were saved. The more recent bookmarks will appear on the top of the list.

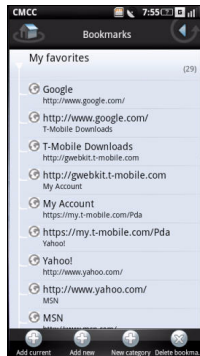

To add bookmarks:

- 1 Open the Browser screen and press the **Options** button to open the Options panel.
- 2 Tap **Bookmarks** on the Options panel to open the Bookmarks screen.

Using Internet Features

- 3 Press the **Options** button again to open the Options panel.
- 4 Tap **Bookmark page** to open the Bookmark link screen.

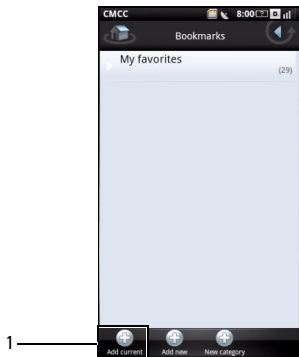

- 1 **Bookmark** page icon

- 5 Type the bookmark name and location (URL) in the dialog boxes and choose the category from the drop-down list.

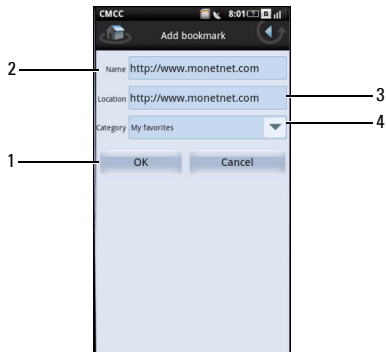

- 1 **OK** icon
 - 2 **Name** dialog box
 - 3 **Location** dialog box
 - 4 **Category** drop-down list
- 6 Tap the **OK** icon to save and exit the screen.

Accessing Browser Options

The following Browser Options are available by tapping the **More** icon on the Options panel:

- **History** — View the web pages you visited recently.
- **Downloads** — View the history of your downloads.
- **Advanced** — View advanced settings.
- **Find on Page** — Search the web page.
- **Settings** - Browser settings (see “Changing Browser Settings” on page 76).

- **Exit** — Exit the menu.

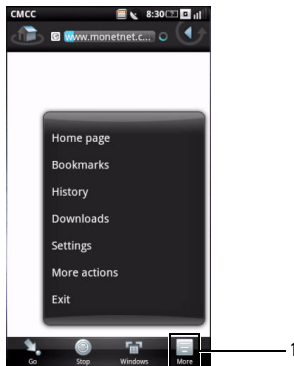

- 1 **More** icon

Changing Browser Settings

The following are the available Browser settings:

- **Text size** — Select this setting to set the size of the text displayed on web pages.
- **Block pop-up windows** — Select this check box to prevent pop-up windows from appearing.
- **Load images** — Select this check box to display images on web pages.
- **Enable JavaScript** — Select this check box to enable Javascript.
- **Set home page** — Select this setting to set your home page.
- **Search portal** — Select this setting to set the default search engine to use.
- **Data connection** — Select this setting to set the data network to which you wish to connect.
- **Clear cache** — Select this setting to delete all cached page contents.
- **Clear history** — Select this setting to clear the browser navigation history.
- **Accept cookies** — Select this check box to allow sites to save and read “cookie” data.
- **Clear all cookie data** — Select this setting to delete all browser cookies.
- **Remember form data** — Select this check box to save the data you typed in forms for later use.
- **Clear form data** — Select this setting to delete all saved form data.
- **Remember passwords** — Select this check box to save usernames and passwords for web sites.
- **Clear passwords** — Select this setting to delete all saved passwords.
- **Show security warning** — Select this check box to show security warnings if there is a problem with a web site.
- **Restore to default** — Select this setting to clear all browser data and reset all settings to factory default.

To change Browser settings:

- 1 Open the Browser's home page.
- 2 Press the **Options** button to open the Options panel.
- 3 Tap **More Settings** on the Options panel.



NOTE: To change the Browser settings, you must be on the Browser's home page.

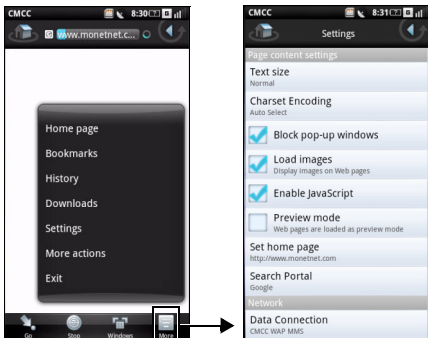

Using Email Features

Introducing 139 Mail

139 Mail is your default email client. It allows you to use your phone number as an email account to send and receive messages using the Internet, SMS, MMS, or WAP mobile Internet access. Besides 139 Mail, you can use 21cn, Gmail, and more that are also included or add your own email clients. Contact your email providers for the required setup information.

To use 139 Mail, 21cn, Gmail, or other email services, select **139 Mail** from the Home screen and select **Enter** at the welcome screen. The Account Settings screen opens.



Managing Email Accounts

Adding an Account From 139 Mail, 21cn, or Gmail

- 1 Tap **139 Mail**, **21cn**, or **Gmail** from the Account Settings to open the account input screen.
- 2 Enter your user name, password, and from name.



- 3 Press the **Options** button to open the Options panel and tap **Save** to save your account settings. The Accounts screen appears.
- 4 Tap the account you just set up to open your email account and start sending and receiving emails.
- 5 To exit this screen tap the **Back** icon.

Using Email Features

To add more accounts, press the Options button and select **New Account** on the Options panel.

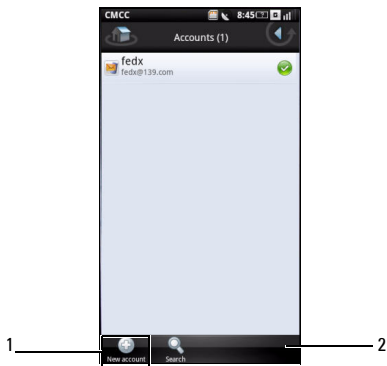

2 **New Account** icon

2 Options Panel

Setting Up and Editing Accounts

Open 139 Mail by tapping **139 Mail** from the Home screen.

If you have not added an account, you can tap **Set up manually** to create a new account.

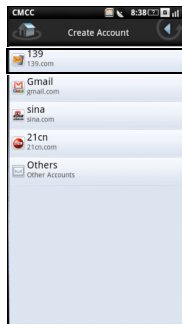

NOTE: Contact your email providers for the required setup information.

To edit your account settings:

- 1 Tap to select the email account you want to edit.
- 2 Scroll through the list and select the setting you would like to change.
- 3 Tap **OK** when you are done to save and exit each change.

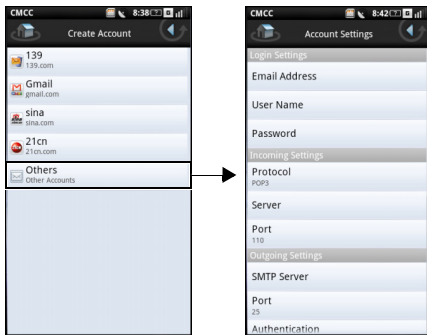

The following are the available **Email Account** settings:

- **Email Address** — Select this setting to edit your email address
- **User Name** — Select this setting to edit your user name.
- **Password** — Select this setting to edit your password for the account.
- **Protocol** — Select this setting to choose the protocol used to send and receive emails including POP3, POP3/SSL, CMPCP, and CMPCP/SSL. Contact your service provider for information.
- **Server** — Select this setting to edit the address of the server that provides your mail.
- **Port (Incoming)** — Select this setting to edit the port value used for incoming traffic.
- **SMTP Server** — Select this setting to edit the address of the server through which you send your mail.
- **Authentication** — Select this setting to select the authentication type for your mail.

Using Email Features

- **Port (Outgoing)** — Select this setting to edit the port value used for outgoing traffics.
- **Data Connection** — Select this setting to select the CMCC network to use for data connection.
- **Delete email from server** — Select this setting to choose how emails are deleted from the server.
- **Reply to mails with the original** — Select this check box to include the original messages when you reply mails.
- **Poll Frequency** — Select this setting to select how often automatic POP3 retrievals are performed.
- **Read Limit** — Select this setting to set the read limit for your emails if you wish to set a send/receive message size limit. You can select Headers Only, First 5k, First 10k, or Entire Message. Notice that setting the limit to Headers Only will allow you to only see the message subjects.
- **From name** — Select this setting to edit your full name displayed to recipients.

- **Signature** — Select this setting to input your signature.

Removing an Account

- 1 Tap **139 Mail** from the Home screen.
- 2 Tap and hold the email account you want to remove to open the function menu.
- 3 Select **Delete** to remove the account.
- 4 Tap the **Back** icon to exit the screen.

Managing Email Messages

Sending Emails

- 1 Tap **139 Mail** from the Home screen and tap an email account to open the email screen.
- 2 Tap **Inbox** to open your inbox folder.

- Press the Options button and select **Compose** to open the Compose Mail screen.

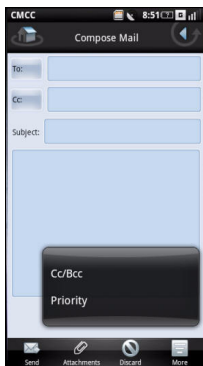

- Type a subject and message.
- Press the Options button to select **CC/BCC** or **Priority** on the Options panel.
- To exit this screen tap the **Back** icon.

Receiving Emails

- Tap **139 Mail** from the Home screen and tap an email account to open the email screen. The email screen contains Inbox, Sent, Drafts, Outbox, and Trash.
- Press the Options button and select **Receive/Send** on the Options panel to receive new mails.

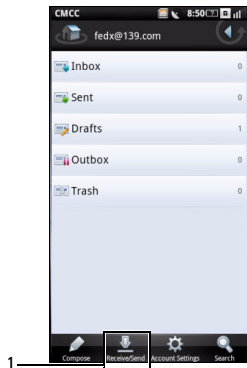

Using Email Features

- 1 **Receive/Send** icon
- 3 Tap **Inbox** to open your inbox folder and read your unread mails.
- 4 To exit this screen tap the **Back** icon.

Deleting Messages

- 1 Tap **139 Mail** from the Home screen and tap an email account to open the email screen.
- 2 Tap **Inbox** to open your inbox folder.

- 3 Tap the message you want to delete to select it.

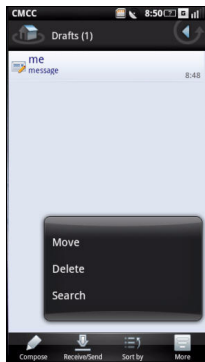

- 4 Press the Options button and tap **More** from the Options panel.
- 5 Tap **Delete**. Your message is moved to the Trash folder.
- 6 Tap the **Back** icon to exit this screen.

Deleting Email Permanently

- 1 Tap **139 Mail** from the Home screen and tap an email account to open the email screen.
- 2 Tap **Trash** to open the Trash folder.
- 3 Tap the message you want to delete to select it.

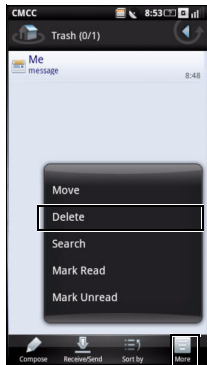

- 4 Press the Options button and tap **More** from the Options panel.

- 5 Tap **Delete**.
- 6 Tap the **Back** icon to exit this screen.

Using Fetion

Fetion is a messaging application that lets you send free messages to friends, make low charge voice group chats and exchange files between cell phones and computers. Go to www.fetion.com.cn for more information and download Fetion for your phone.

Using Email Features

To open Fetion, tap **Fetion** from the Home screen. You are logged in automatically if **Auto Login Fetion** is enabled.

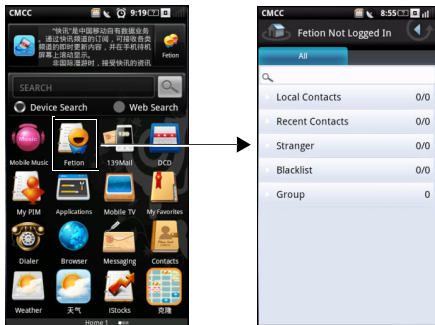

- 2 Press the Options button to open the options panel.

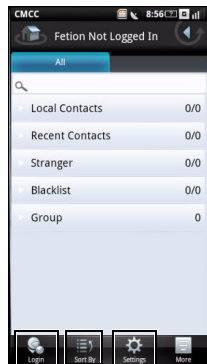

Managing Your Fetion Account and Messages

- 1 Tap **Fetion** from the Home screen.

- 3 To log on to Fetion manually, tap **Login** on the Options panel.
- 4 To sort your messages, tap **Sort By** to sort your messages.
- 5 To get help, tap **Help**.
- 6 To exit Fetion, tap **More > Exit**.

Changing Fetion Settings

To edit your Fetion settings, select **Fetion** from the Home screen and press the Options button to select **Settings**.

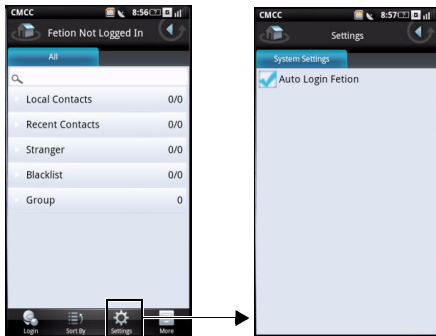

The following **Fetion** settings are available:

- **Auto Login Fetion** — Select this check box to enable auto login.

Using My Favorites

My Favorites lets you to watch videos, capture and view photos, and listen to and record audio files on your phone. Tap **My Favorites** from the Home screen to open **My Favorites**.



Browsing and Playing Music

- 1 To open Music, select **My Favorites** > **Music** from the Home screen.

Your music is organized into five categories: Albums, Artists, Tracks, Genres, and Playlists. Select a category to view the lists within each.

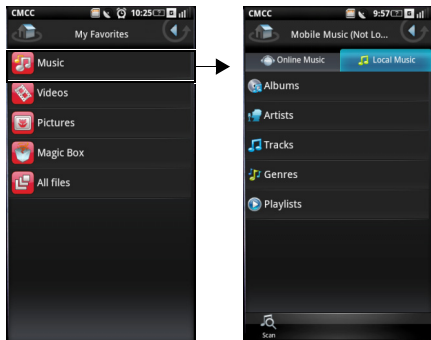

- You may start **Party shuffle** (all the songs in your library are added to a playlist in random order) by pressing the Options button then tap **Party shuffle**.

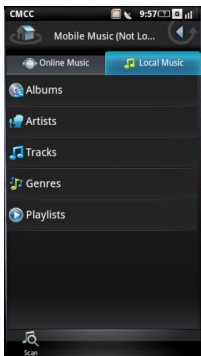

- To browse all audio files on the phone including the SIM card and the microSD card, press the Options button then tap **Search**.

- Double tap any song to start playing the song.

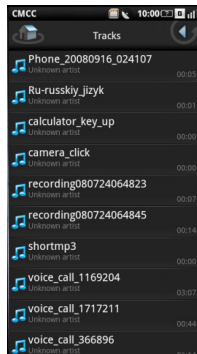

Managing Music Files

Creating a Playlist

- From the Tracks screen, select a category.

Using My Favorites

- From the list that appears, navigate to the artist, album, or song that you want on a playlist.
- Long tap the artist, album, or song to open the function menu. Tap **Add to playlist**.
- In the **Add to playlist** menu that opens, select **My favorites** or other ones you created.

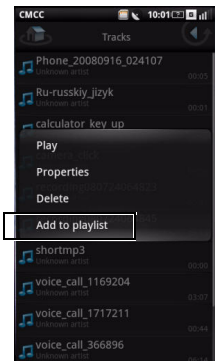

NOTE: You can also use this menu to Play, change Properties, or Delete the songs.

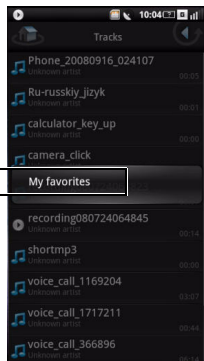

The selected song(s) are added.

Managing Playlists

Go to the **Music** screen and select **Playlists**. All your playlists appear.

Select the playlist to play the songs in the list.

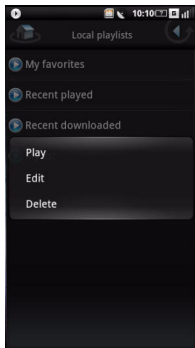

You can long tap the playlist to open the function menu and select **Play** to play the songs.

To exit this screen tap the **Back** icon.

Creating Ringtones From Songs

- 1 Tap the song you wish to set as ringtone to open the Music Player.

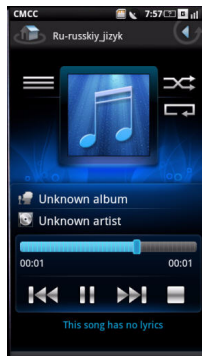

- 2 Press the Options button to select **Set ringtone**. The ringtone is set as your default incoming call ringtone.







Understanding the Music Player

- 1 To open the Music Player, short tap an audio file. The Music Player appears on the screen.



- 1 Time elapsed
- 2 Progress bar
- 3 Artist
- 4 Album
- 5 View current playlist
- 6 Shuffle model
- 7 Repeat songs
- 8 Album art
- 9 Total Time
- 10 Playback controls
- 11 Lyrics

2 To use the Music Player controls:

-  Tap to pause
-  Tap to play
-  Enable shuffle mode and play songs randomly
-  Repeat all songs or only the current song
-  Tap to go to the next song
-  Tap to go to the previous song

Browsing and Playing Videos

- 1 Tap **My Favorites** on the Home screen.
- 2 Tap **Videos** on the My Favorites screen.

3 Your videos are displayed as a thumbnail list.

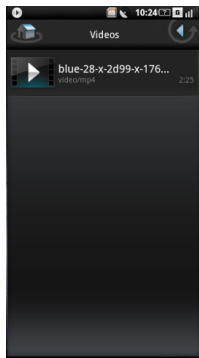

- 4 Slide your finger up and down on the list to view the entire list.
- 5 To exit the screen tap the **Back** icon.

Managing Videos

To sort videos:

- 1 Press the Options button and tap the **Sort by name** or **Sort by time** icon to sort your videos.

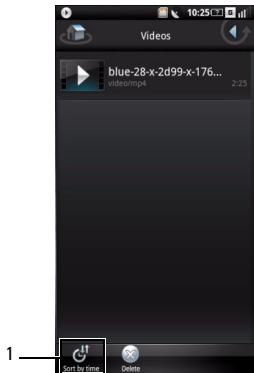

- 1 **Sort by time icon**
Sort by name icon

- 2 To exit the screen tap the **Back** icon.

To delete a file on the list:

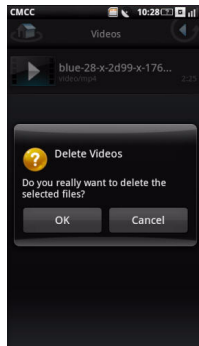

- 1** Long tap a video file to open the function menu.
- 2** Tap **Delete** to delete the video file.
- 3** Tap **OK** to confirm.

To view video properties:

- 1 Long tap a video file to open the function menu.
- 2 Tap **Property** to view the properties of the selected video file.

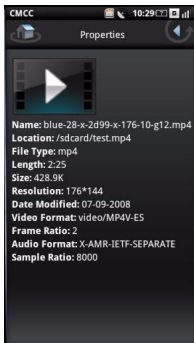

- 3 Tap the **Back** icon to exit the screen.

To delete multiple videos:

- 1 To delete multiple videos, press the Options button and tap **Delete** to open the Delete screen.
- 2 Tap to check the check boxes of the videos you want to delete.

You can also press the **Options** button and tap **Select All** to select all files.

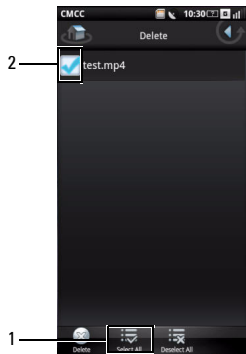

- 1 **Select All** icon
- 2 Check box
- 3 Press the **Options** button to open the Options panel and tap **OK** to delete the files.

Using the Video Player



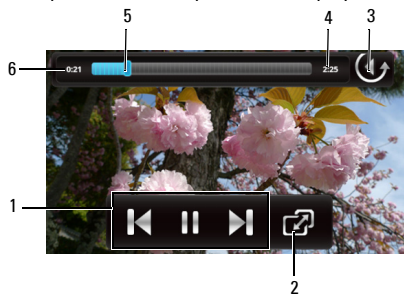

Short tap a video file to open the Video player.



- 1 Playback controls
- 2 Switch screen mode
- 3 Back icon
- 4 Time remaining
- 5 Progress bar
- 6 Time elapsed

To use Video player:

Use the following icons on the video player to control video playback

-  Tap to pause video
-  Tap to view full screen
-  Tap to play next video
-  Tap to play previous video

Using the Picture Application

- 1 Tap **My Favorites** on the Home screen.

Using My Favorites

- 2 Tap **Pictures** on the My Favorites screen.

Browsing Pictures

Your pictures are displayed as thumbnails. Slide your finger up and down on the list to view the entire list.

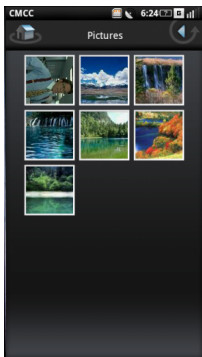

- 1 Short tap a thumbnail to view the photo in full screen view.

- 2 Tap the **Zoom in** icon to enlarge the view of the picture and **Zoom out** icon to reduce the view of the picture.
- 3 Swipe your finger to the left or right to go to the previous or next picture.
- 4 Press the **Options** button and then tap **More** in the Options panel.

- 5 Tap **Properties** to view the properties of the selected picture.

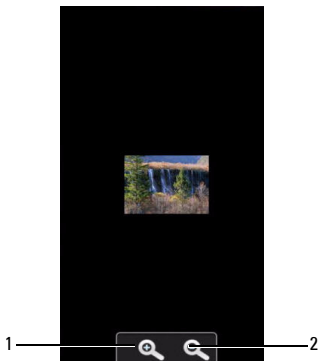

 **NOTE:** Multi touch is enabled to enlarge or minimize the images on the screen.

- 1 **Zoom in** icon
 - 2 **Zoom out** icon
- 6 Tap the **Back** icon to exit the screen.

To rotate pictures:

- 1 To rotate pictures, press the **Options** button in either the thumbnail view or the full screen view to open the **Options** panel.
- 2 Tap **Rotate**, and then tap **Rotate left** or **Rotate right** to rotate the picture.
- 3 Tap the **Back** icon to exit the screen.

To view pictures as a slideshow:

- 1 Press the Options button in either the thumbnail view or the full screen view to open the Options panel.

- 2 Tap Slideshow to begin slideshow.

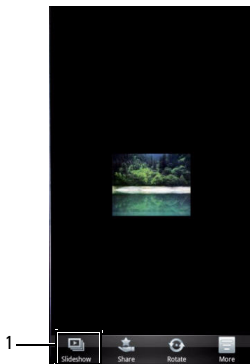

- 1 **Slideshow** icon
- 3 Tap anywhere on the screen to stop the slideshow.
- 4 Tap the **Back** icon to exit the screen.

Managing Picture Files

To delete a picture:

- 1 Short tap the thumbnail of the picture you want to delete to bring up full screen view.
- 2 Press the Options button then tap **More** to open the function menu.
- 3 In the function menu, tap **Delete** to delete the picture.

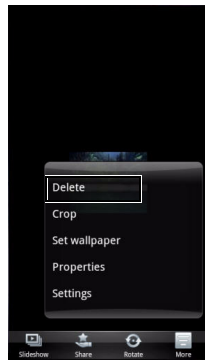

- 4 Tap **OK** to confirm.

To crop a picture:

- 1 Short tap the thumbnail of the picture you want to delete.
- 2 Press the **Options** button then open the function menu.
- 3 In the function menu, tap **Crop** to open the crop screen.

- 4 Tap and hold an edge of the frame to reveal the sizing arrows, then drag the edge in or out to fix the crop size. Tap and slide the center of the frame to move it within the picture.

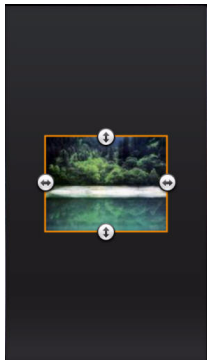

- 5 Press the Options button then tap **Save** to save the cropped picture as a new copy and exit the screen.

To share pictures:

- 1 Short tap the thumbnail of the picture you want to delete.
- 2 Press the Options button then open the function menu.
- 3 In the function menu, tap **Share** to open the pop-up menu.
- 4 Select your application for sharing from the menu to open the Compose screen.

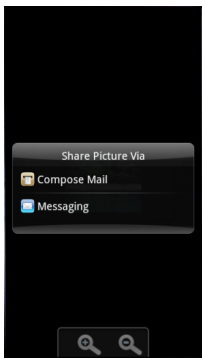

- 5 Complete your message and tap **Send** to send the message with the picture and return to the main screen.

Changing Picture Settings

To open Picture settings, press the **Options** button then select **Settings**.

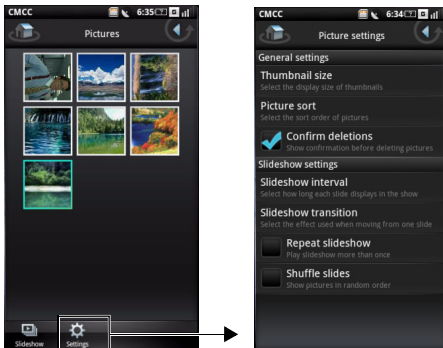

The following are the available picture settings:

- **Thumbnail size** — You can select from Large or Small picture display sizes.
- **Picture sort** — You can select to sort pictures with the newest pictures first or newest pictures last.
- **Confirm deletions** — Select this check box if you want confirmations before deleting pictures.
- **Slideshow interval** — Select the duration each slide appears on the screen. The options available are 2, 3, or 4 seconds.
- **Slideshow transition** — Select the effect used when moving from one slide to another. The options available are Fade in & out, Slide left-right, Slide up-down, and Random.
- **Repeat slideshow** — Select this check box to play the slideshow more than once.
- **Shuffle slides** — Select this check box to shuffle your pictures in the slideshow.

Using the Camera

You can use the camera to take photos and video clips.

To activate camera, press the Camera button or select **My Favorites > Camera** from the Home screen. Camera screen is displayed in the landscape view.

Camera mode

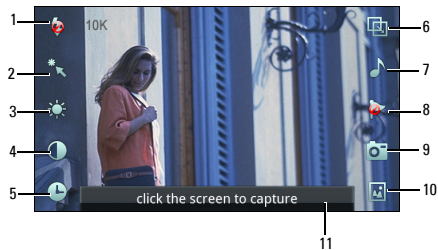

- 1 Flash status
- 2 Exposure compensation setting icon
- 3 Brightness
- 4 Contrast
- 5 Auto Timer
- 6 Image Size
- 7 Audio
- 8 Flag

- 9 Capture mode
- 10 White balance setting icon
- 11 Tap to capture

Using the camera:

Tap the **click the screen to capture** bar to capture photo.

Tap the **White balance setting** icon to set up White balance.

Tap the **Exposure compensation setting** icon to set up Exposure compensation

Tap the **Capture mode** icon to switch to video recorder mode.

Using Video Recording Mode

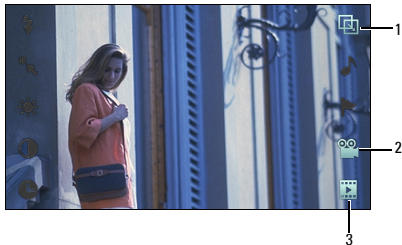

Using the video recorder:

- 1 Image Size
- 2 Recording mode
- 3 Tap to review your recorded videos

Using the Recorder Application

The Recorder feature allows you to capture audio notes for yourself. To open the Recorder, select **My Favorites > Sound Recorder** from the Home screen.



- 1  **Start recording** icon
- 2  **Playback** icon
- 3  **Stop** icon

Using the Recorder:

- Tap the **Start recording icon** to start recording.
- Tap the **Playback** icon to playback recording.
- Tap the **Stop** icon to stop recording or playback.

Using Applications

This section provides information about the additional applications available on your smartphone.

Messaging

You can send and receive text messages using the Messaging program. To open Messaging, select **Messaging** from the Home screen.

To read unread messages

The **Unread Messages** icon indicates unread messages for the contacts on your Messaging list. To read a message, tap the contact with the unread message.

To reply to a message

- 1 Select **Messaging** from the Home screen to open the Messaging screen.

- 2 Select a contact from the Messaging list to open the Compose screen.
- 3 Type in your message.
- 4 Tap **Send** to send your message.

To send messages to your contacts

- 1 Select **Messaging** from the Home screen to open the Messaging screen.

- 2 Press the Options button and select **Compose** on the Options panel to open the Compose screen.

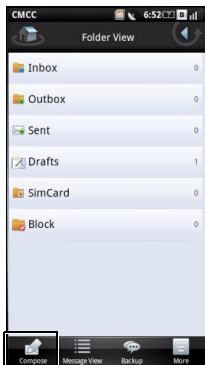

- 3 Tap **To:** to open Contacts and select the check boxes of the contacts you want to message.

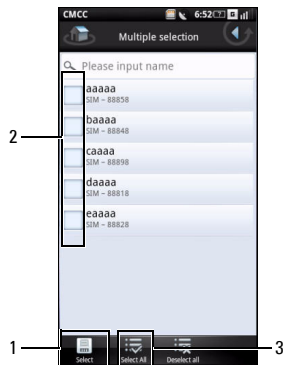

- 1 **Select contacts** icon
- 2 check boxes
- 3 **Select all** icon

- 4 Press the Options button and select **Select Contacts** or **Select All** on the Options panel to send the message.

To add more to messages

- 1 Select **Messaging** from the Home screen to open the Messaging screen.
- 2 Press the Options button and select **Compose** on the Options panel to open the Compose screen.
- 3 At the Compose screen, press the Options button to open the Options panel.

- 4 You can use the Options panel for functions including Save Draft, Attach, Add subject, and Discard.

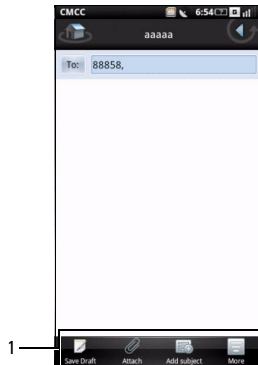

- 1 Options panel functions

To open Folder View

- 1 Select **Messaging** from the Home screen to open the Messaging screen.
- 2 Press the Options button and select **Messaging View** on the Options panel to open the Message Folder.

- 3 Select a folder such as Inbox, Outbox, Sent, Drafts, SimCard, or Block to read your messages.

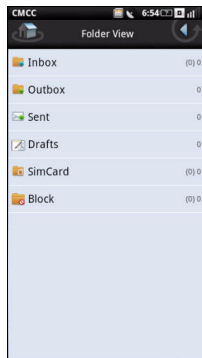

To backup messages

- 1 Select **Messaging** from the Home screen to open the Messaging screen.

- Press the Options button and select **Messaging Backup** to open the Backup Restore screen.

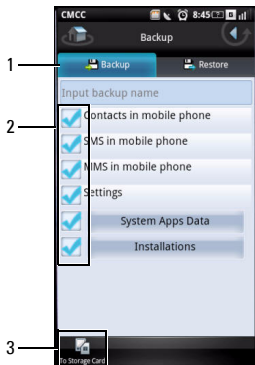

- Backup** tab
- check boxes
- To Storage Card** icon

- Select the **Backup** tab on top to view the Backup screen.
- Select the check boxes to choose what to backup.
- Press the Options button and select **To Storage Card** on the Options panel to start backing up data.

To restore data

- Select **Messaging** from the Home screen to open the Messaging screen.
- Press the Options button and select **Messaging Backup** to open the Restore screen.
- Select the **Restore** tab on top to view the Backup screen.
- Select a restore source to start restoring your data.

Messaging Settings

This section provides information on changing the Messaging Settings including SMSC, Expiry Time, Delivery reports, Read reports, Auto-retrieve, Roaming auto-retrieve, Data Connection, Service Center, and Signature.

To edit your Messaging settings, press the Options button at the Messaging screen and select **More > Settings**.

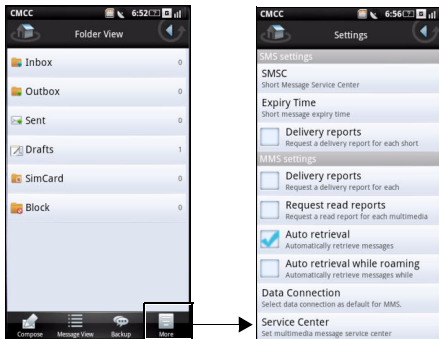

The following are the available settings:

Expire Time

Select this setting to set the short message expiry time. The available options are One Hour, Twelve Hour, One Day, Seven Day, and Unlimited.

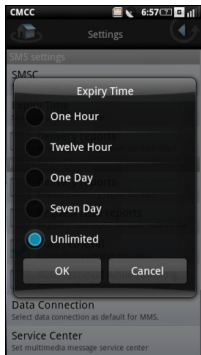

Request Read Reports

Select this check box to request a read report for each message you send.

Auto-retrieval

Select this check box to retrieve messages automatically.

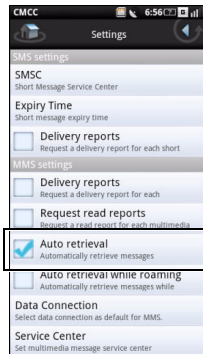

Auto-retrieval while roaming

Select this check box to retrieve messages automatically when roaming outside of your service area.

Data Connection

Select this setting to set your default data connection for multimedia. The available options are CMCC HTTP, CMCC MAIL, CMCC NET, CMCC WAP, and CMCC WAP MMS.

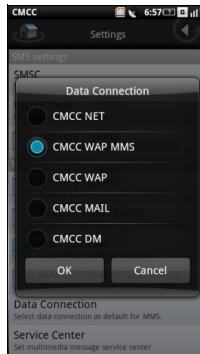

Tap **OK** to save and exit.

Service Center

Select this setting to enter the Service Center address for your multimedia. Contact your service providers for this information.

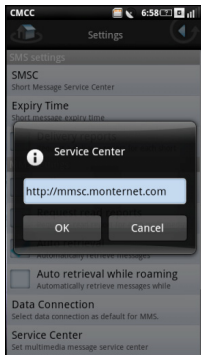

Tap **OK** to save and exit.

Signature

Select this setting to set a signature to your MMS. Signature is appended to every MMS message you send.

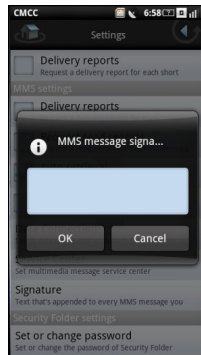

Tap **OK** to save and exit.

Calendar

The Calendar lets you assign events such as appointments or specific tasks to a date or time and receive reminders to remind you of the events. You can view your events in a continuous list, by day, by week, or by month. To open the Calendar, select **Calendar** from the Home screen.



Calendar Views

Month view

The blue color on vertical bars represent events you have added.

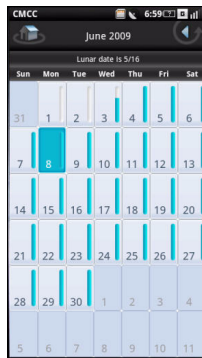

To view event details, select a day to view all events in that day then select an event to view its details.

To navigate months, slide your finger up or down through the days and past the beginning or end of the month to move to the previous or next month.

To jump to the current day, press the Options button and select **More > Jump to today**.

Agenda view

Agenda view displays all events in the current month.

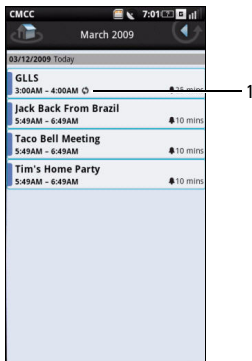

1 Repeating Events icon

Select the event to view its details.

Repeating events are marked with the **Repeating events** icon.

To navigate to a past or future month, slide your finger to the left or right on the screen.

To jump to the current day, press the Options button and select **More > Jump to today**.

To exit the screen tap the **Back** icon.

Week view

Using Applications

Events are shown as blocks in week view.

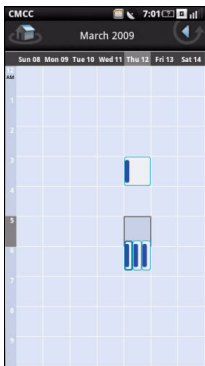

Select an event to open the pop-up window that displays more event information. Tap the pop-up window to view the event details.

To navigate within the current week, slide your finger up or down on the screen.

To navigate to a past or future week, slide your finger to the left or right on the screen.

To jump to the current day, press the Options button and select **More > Jump to today**.

To exit the screen tap the **Back** icon.

Day view

Events are shown tiled and span the time they last. All-day events are displayed at the top of the day list.

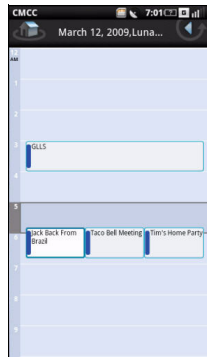

Select an event to open the pop-up window that displays more event information. Tap the pop-up window to view the event details.

To navigate within the current week, slide your finger up or down on the screen.

To navigate to a past or future week, slide your finger to the left or right on the screen.

To jump to the current day, press the Options button and select **More > Jump to today**.

To exit the screen tap the **Back** icon.

Using the Calendar

To add a new event

- 1 Select **Calendar** from the Home screen to open Calendar.

- 2 Press the Options button to select **New event** on the Options panel or select a date or time in the calendar to open Event details.

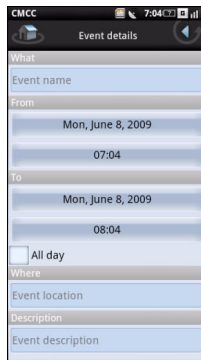

- 3 Select the duration of the event and enter event details and set reminders if required.
- 4 Press the Options button then tap **Save** on the Options panel to save and exit.

Using Applications

To edit an event

To edit an event, select the event to view its details then press the Options button to select **Edit event** on the Options panel.

To exit the screen tap the **Back** icon.

Calendar Settings

To edit Calendar settings, press the Options button and select **More > Settings** on the Options panel. You can set up **Hide declined events**, **Set default view**, **Set alert & notifications**, and **Set default reminder** in Calendar Settings.



The following are the available settings:

Hide declined events

Select this check box to have all declined events hidden.

Set default view

Select this setting to set the default view for your calendar. You can set your default view to Month view, Week view, Day view, or Agenda view.

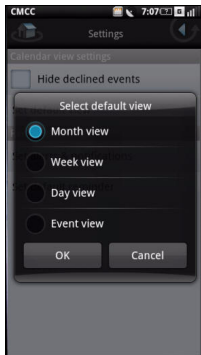

To exit the screen tap the **Back** icon.

Set alerts & notifications

Select this setting to set the type of event reminder you want. You can choose **Alert**, **Status bar notification**, or **Off**.

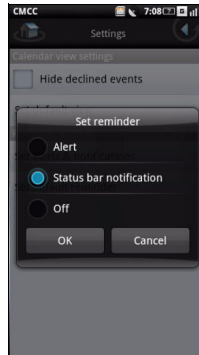

To exit the screen tap the **Back** icon.

Set default reminder

Select this setting to set the default reminder time for your events.

To exit the screen tap the **Back** icon.

Alarm Clock

To use Alarm Clock, select **Alarm** from the Home screen.

To set an alarm:

- 1 Select **Alarm** from the Home screen to open the Alarm Clock.

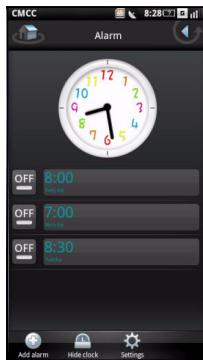

- 2 Select one of the default alarms to open the Set Alarm screen.

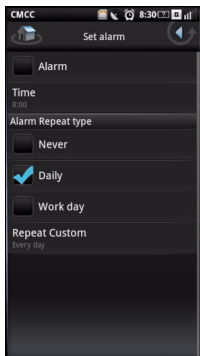

- 3 Select **Time** to set the alarm time.
- 4 Select Repeat to select the days of the week to repeat the alarm. If you want the alarm for one time only, you do not have to select any option in the **Alarm repeat type** section.
- 5 Select the **Alarm** check box to turn on the alarm.

- 6 To exit the screen, tap the **Back** icon.

To add more alarms:

- 1 Select **Alarm** from the Home screen to open Alarm Clock.
- 2 Press the Options button to open the Options panel.
- 3 Select **Add alarm** on the Options panel.

To change clock display:

- 1 Select **Alarm** from the Home screen to open Alarm Clock.

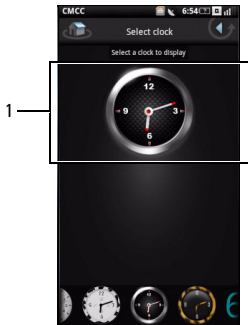

- 2 Tap the clock to open the Select clock screen.
- 3 Slide your finger to the left and right to browse through the selections at the bottom of the screen and tap to select the clock you prefer.

To hide the clock:

- 1 Select **Alarm Clock** from the Home screen to open Alarm Clock.
- 2 Press the Options button to open the Options panel.

1 Clock

- 3 Select **Hide clock** on the Options panel.

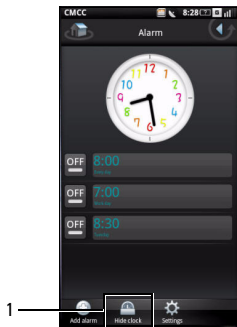

- 1 **Hide clock** icon
- 4 To exit the screen, tap the **Back** icon.

To set up date & time:

- 1 Select **Alarm** from the Home screen to open Alarm Clock.
- 2 Press the Options button and select **Date & time settings** on the Options panel.

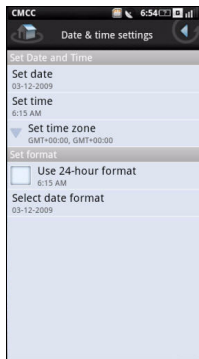

- 3 Select the **24 hour format** check box if you wish to use the 24 hour format.

Using Applications

- 4 Tap the **Select date format** option to choose your date formats.
- 5 To exit the screen, tap the **Back** icon.

Calculator

Calculator allows you to perform basic mathematic calculations. To open the Calculator, tap **Calculator** from the Home screen.



- 1 **Clear** icon

- Tap the **Clear** icon to clear your entry.
- Use the numeric keys to enter numbers.
- Use +, -, x, ÷, = to perform calculation.
- To exit the screen, tap the **Back** icon.

File Manager

The File Manager allows you to browse and manage the contents of your memory card and phone. To open the File Manager, select **File Manager** from the Home screen.

To view stored files:

- 1 In the Home screen, tap the **File Manager** to open the File Manager.
- 2 Select the **SD Card** tab to view files stored in the microSD card or select the **Phone** tab to view files stored on the phone.

- 3 Select a folder to view files inside the folder.

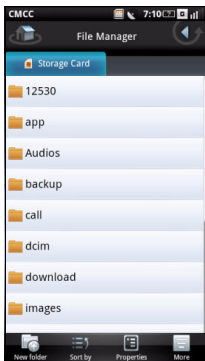

- 4 To exit the screen, tap the **Back** icon.

To add new folders:

- 1 In the Home screen, tap the **FileManager** to open the File Manager.

- 2 Press the Options button and select **New folder on the Options panel.**

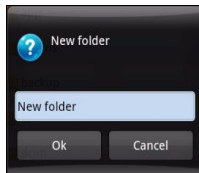

- 3 Enter the folder name and tap **OK.**

To sort files and folders:

- 1 In the Home screen, tap the **FileManager** to open the File Manager.
- 2 Press the Options button and select **Sort by** on the Options panel.

Using Applications

- 3 Select **name**, **size**, **time**, or **type** to sort your files and folders by name, size, date, or type.

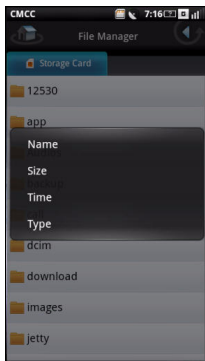

- 4 To exit the screen, tap the **Back** icon.

To delete files and folders:

- 1 In the Home screen, tap the **FileManager** to open the File Manager.

- 2 Press the Options button and select **More > Delete** on the Options panel.
- 3 Select the check boxes of the files or folders you want to delete.

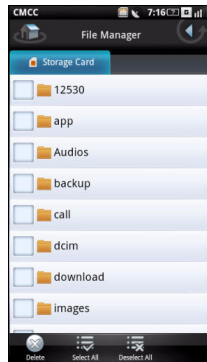

- 4 You can also select a file or folder directly by long tapping the file or folder and then tap **Delete** on the Options panel.

- 5 Press the Options button and select **Delete** on the Options panel, then select **Yes** to confirm deletion.

To cut, copy, and paste:

- 1 In the Home screen, tap the **FileManager** to open the File Manager.
- 2 Press the Options button to open the Options panel.
- 3 Select **More > Cut** to cut, or **More > Copy** to copy.
- 4 Select the check boxes that appear beside the files or folders you want to cut or copy.

- 5 You can also select a file or folder directly by long tapping the file or folder and select **Copy** or **Cut** on the function menu.

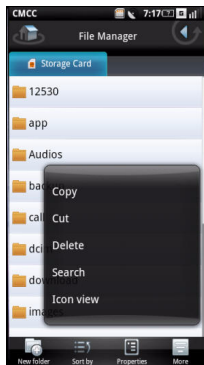

- 6 Press the Options button and select **Copy** or **Cut** on the Options panel then select **Yes** to confirm deletion.
- 7 Select a folder or storage for insertion.

Using Applications

- 8 Press the Options button and select **More > Paste** to move the files or folders to the new destination.
- 9 To exit the screen tap the **Back** icon.

To search for contents:

- 1 In the Home screen, tap the **FileManager** to open the File Manager.
- 2 Press the Options button and select **More > Search** on the Options panel. The Search screen appears.
- 3 Enter your search terms and tap the **Search** icon to begin the search.
- 4 Your search results are sorted by categories and listed in tabs. Select the tabs to view the search results.
- 5 To exit the screen, tap the **Back** icon.

To change the view:

- 1 In the Home screen, tap the **FileManager** to open the File Manager.

- 2 Press the Options button and select **More > Icon view** or **More > List view** on the Options panel to change the view.



To rename files or folders:

- 1 In the Home screen, tap the **FileManager** to open the File Manager.

- 2 Long tap the file or folder you want to rename to open the function menu.
- 3 Select **Rename** on the function menu to open the rename screen.



- 4 Enter the new name and tap **OK** to save and exit the screen.

To compress files or folders:

- 1 In the Home screen, tap the **FileManager** to open the File Manager.
- 2 Long tap the file or folder you want to compress to open the function menu.



Using Applications

- 3 Select **Compress** on the function menu to open **Zip to screen**.



- 4 Enter the name for your zip file, and tap **OK** to save and exit the screen.

To decompress files or folders:

- 1 Select the zipped file or folder to open **Unzip to screen**.

- 2 Enter the name for your unzip file and tap **OK** to save and exit the screen.

Notes

In the Home screen, tap **Notes** to open the Notes screen.

To add notes:

- 1 Select **Notes** from the Home screen to open Notes.

- Press the Options button and select **Add** on the Options panel. The Create note screen opens.



- Enter the title and the content.
- Press the Options button and select **Save** on the Options panel.
- To exit the screen, tap the **Back** icon.

To read notes:

Notes are listed by date added, with the most recent note at the top. You can see the title of each note in the list. Select the note to view its details.



To exit the screen, tap the **Back** icon.

To edit notes:

- 1 Select **Notes** from the Home screen to open Notes.
- 2 Select the note you want to edit to view its details.
- 3 Make the required edits to the note.
- 4 Press the Options button and select **Save** on the Options panel.

To delete notes:

- 1 Select **Notes** from the Home screen to open Notes.
- 2 Press the Options button and select **Delete** on the Options panel.

- 3 Select the check boxes that appear beside the notes you want to delete.

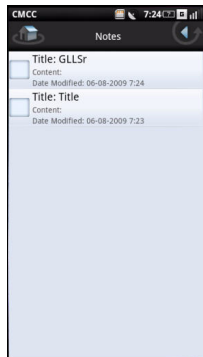

- 4 Press the Options button and select **Delete** on the Options panel to delete the note.
- 5 To exit the screen tap the **Back** icon.

To Do List

To Do List allows you to keep track of tasks you need to do. To open To Do List, select **To Do List** from the Home screen.

To create new tasks:

- 1 Select **To Do List** from the Home screen to open To Do List.
- 2 Press the Options button to open the Options panel.
- 3 Select **Add** to open the Create Task screen.
- 4 Enter task title, date and time, task details, priority, and status.

- 5 Press the Options button and select **Save** on the Options panel.

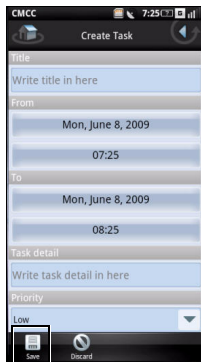

- 6 To exit the screen, tap the **Back** icon.

To edit tasks:

- 1 In the main To Do List screen, select the task you want to edit.
- 2 The Edit Task screen opens.

Using Applications

- 3 Make the required edits to the task.
- 4 Press the Options button and select **Save** on the Options panel.

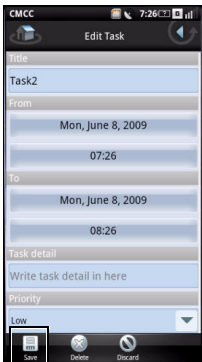

- 5 Tap the **Back** icon to exit the screen.

To delete tasks

- 1 In the main **To Do List** screen, press the Options button and select **Delete** on the Options panel.
- 2 Select the check boxes that appear beside the tasks you want to delete.
- 3 Press the Options button and select **Delete** on the Options panel to delete the task.

World Clock

World Clock allows you to view and add the time in other major cities and time zones around the world. To open World Clock, tap **World Clock** from the Home screen.

To view clocks:

- 1 Select **World Clock** from the Home screen to open World Clock.

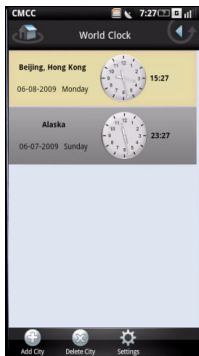

- 2 Slide your finger up and down to browse the clocks.

To add clocks:

- 1 Select World Clock from the Home screen to open World Clock.
- 2 Press the Options button and select **Add City**.
- 3 Select the city or time zone to add the clock.
- 4 Press the Options button and select **Add City** on the Options panel, then back to the screen.

To delete clocks:

- 1 Select **World Clock** from the Home screen to open World Clock.
- 2 Press the Options button and select **Delete City** to open the Delete City screen.

Using Applications

- 3 Select the check boxes that appear beside the names of the clocks you want to delete.

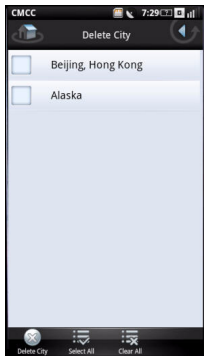

- 4 Select **Delete City** to confirm deletion and exit the screen.

Clock setting

Date and time settings appears when you select **Setting** from the Options panel. See “Date & Time Settings” on page 39 for set up instructions.

Applications

Program Manager

Program Manager allows you to manage your programs. To open Program Manager, select **ProgMng** from the Applications folder of the Home screen.

Toolbox

Toolbox allows you to manage installed programs on your device.

Search

To open Search, tap **Search** from the Home screen.

Using Search

Simple search

1. Tap **Search** on the Home screen to open Search.



2. Enter your search terms and tap the **Search** icon to begin the search.
 - You can also find the Search bar at the top of the Home screen.

3. Your search results are sorted by categories and listed in tabs. Select the tabs to view the search results.

Select search preferences

- 1 Tap **Search** on the Home screen to open Search.
- 2 Press the Options button and select **Settings > Search Category**.
- 3 Select the check boxes that appear beside the categories you want to include in your search.
- 4 Press the Options button and select **Save** then exit the screen.

Advanced search

- 1 You can use various options to create a specific search. Tap **Search** on the Home screen to open Search.
- 2 Press the Options button and tap **Advanced Search**. The Advanced Search screen opens.

- 3 Select the drop down menu to select your search preference: **Contacts, Message, File, Call log, or Web History.**

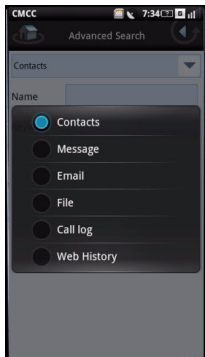

The **Advanced Search** screen appears.

- 4 Enter the search terms and select **Search** to begin search.

Index statistic

- 1 Use Index statistic to view the number of records you have in each program. Tap **Search** on the Home screen to open Search.
- 2 Press the Options button and tap **Index statistic** on the Options panel. The Index statistic screen opens.
- 3 Slide your finger up and down to view the entire list.
- 4 Tap the **Back** icon to exit the screen.

Backup

Use Backup to backup and restore your contacts, messages, and files.

Backup

- 1 Tap **Backup** from the Home screen to open the Backup screen.

- By default, the Backup screen is displayed. If not, select the **Backup** tab on top to view the Backup screen.

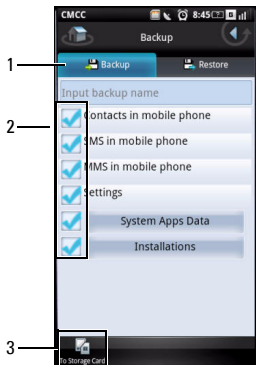

- Backup** tab
- check boxes
- To Storage Card** icon

- Select the check boxes to choose what to backup.
- Press the Options button and select **To Storage Card** on the Options panel to start backing up your data to the storage card.

Restore

- Tap **Backup** from the Home screen to open the Backup screen.
- Tap the **Restore** tab at the top to view the Restore screen.
- Select the restore source to start restoring your data.

DCD

DCD is a data service from the China Mobile Communications Corporation (CMCC). After you order the channels, news will be delivered to your mobile phone and will be shown on the idle screen. If International Roaming is inactive, no data fee will be charged when you use the service (including when you open WAP pages of the service).

Using Applications

To open DCD, select **DCD** from the Home screen.

To view DCD channels:

1. Tap **DCD** from the Home screen to open DCD.
2. Select a Channel to view its details.

DCD Settings

Press the Options button and select **More > Config** to open DCD settings.

The following settings are available:

Connection

Use this setting to select connection modes.

Scrolling

Use this setting to select scrolling speed.

Read-Items Display

Use this setting to show or hide read items.

Close DCD Window

Use this setting to show or hide DCD Window.

PC Sync Tool

You can synchronize the information on your computer with the information on your device. Synchronization compares the data on your device with your PC and updates both the computer and your device with the most recent information. Using the PC sync tool, you can:

- Synchronize information to get the latest information in all locations.
- Transfer files between your device and a PC.
- Backup data stored on the phone.

Installing PC Sync Application

Before beginning synchronization, you must install the PC Sync Tool on your computer.

Installing PC Sync from the microSD card back up folder on your computer (preferred):

- 1 Backup the data from the microSD card to your computer.
- 2 From the microSD card back up folder on your computer, open the **ODS** (Ophone Desktop Suite) folder.
- 3 In the **ODS** folder, double-click the appropriate file (Windows Vista[®] or Windows[®] XP).

Follow the instructions on the wizard to complete the installation.

Installing PC Sync from the microSD card:

- 1 Backup the data from the microSD card to your computer.
- 2 Connect your phone to a USB connector on your computer with the USB to mini-USB cable that shipped with your phone.
- 3 In the Menu that appears on your screen, select **UMS Mode** (USB Mass Storage Mode).

Your computer displays the phone memory as **Removable disk (X)** in **My Computer**, where X is the drive letter on your computer. The drive letter on your computer may vary.

- 4 Double-click **Removable disk (X:)**.
- 5 In the **ODS** folder, double-click the appropriate file (Windows Vista[®] or Windows[®] XP).

Follow the instructions on the wizard to complete the installation.



NOTE: You may be instructed to connect or reconnect the phone to your computer to complete the installation.

Connecting the smart phone

After installing the PC Sync Tool, connect USB cable to the mini USB port on the device and to a PC.



NOTE: You will be prompted to change the phone USB mode. Select SYNC MODE to enable synchronization via USB cable.

Using the PC Sync Tool

Once the connection is established between your device and the PC, you can start synchronization.

The information you can synchronize include Contacts, Calendar, Task, SMS, MMS, and Email.

To synchronize data:

- 1 Select the information you want to synchronize such as Contacts, Calendar, Task, SMS, MMS, and Email.

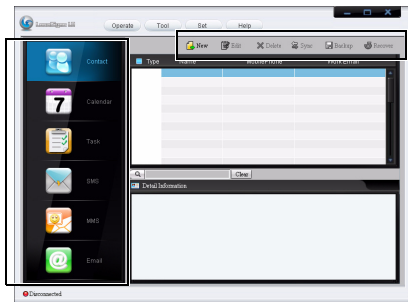

- 2 Select **Sync** to synchronize the files.

To add new data:

- 1 Select the information you want to add such as Contacts, Calendar, Task, SMS, MMS, and Email.
- 2 Select **New** to add new data.

To delete data:

- 1 Select the information you want to add such as Contacts, Calendar, Task, SMS, MMS, and Email.
- 2 Select the data you want to delete.
- 3 Select **Delete** and **OK** to delete the data.

To backup data:

- 1 Select the information you want to add such as Contacts, Calendar, Task, SMS, MMS, and Email.
- 2 Select **Backup** and **OK** to backup the data.

To recover data:

- 1 Select the information you want to add such as Contacts, Calendar, Task, SMS, MMS, and Email.

- 2 Select **Recover**.
- 3 Select **OK** to confirm and start data recovering.

Index

A

Account settings

- Authentication, 81
- Delete email from server, 82
- From name, 82
- Password, 81
- Port (Incoming), 81
- Port (Outgoing), 82
- Protocol, 81
- Read Limit, 82
- Reply mails with the original, 82
- Signature, 82

Alarm Clock

- Add more alarms, 123
- Change clock display, 124
- Hide the clock, 124
- Set an alarm, 122
- Set up date & time, 125

Application Settings

- Phone Lock Setting, 66
- SD card & phone storage, 67
- SIM card lock, 66

B

Backup

- Backing up, 140
- Restore, 141

Battery

- Inserting, 14
- Removing, 14

Bluetooth

- Pairing, 64

C

Calculator, 126

Calendar

 Add a new event, 119

 Agenda view, 117

 Day view, 118

 Edit an event, 120

 Month view, 116

 Week view, 117

Calendar Settings

 Hide declined events, 120

 Set alerts & notifications, 121

 Set default reminder, 122

 Set default view, 121

Calls

 Answer, 53

 Making Calls, 48

 Settings, 55

Camera

 Camera mode, 104

 Using the camera, 105

 Using the video recorder, 105

 Video recording mode, 105

Connection Manager

 Bluetooth settings, 64

 Data Connection, 64

D

date and time, 39

DCD, 141

DCD Settings

 Close DCD Window, 142

 Connection, 142

 Readed-Item Display, 142

 Scrolling, 142

Display settings

 Set brightness manually, 38

 Set up screen time out, 39

E

Entering text

- 4x4Keyboard, 31
- Changing the language, 28
- FullScreenHandWriting, 28
- Numbers and symbols, 29
- Qwerty, 28
- Select input method, 27

F

Fetion

- Exit, 86
- Help, 86
- Log in, 86
- Sort your messages, 86

File Manager

- Add new folders, 127
- Changing display, 130
- Compress files or folders, 131
- Cut, copy, and paste, 129
- Decompress files or folders, 132

- Delete files and folders, 128
- Rename files or folders, 130
- Search for contents, 130
- Sort files and folders, 127
- View stored files, 126

H

- Home screen, 34

M

Mail

- 139 Mail, 78
- Add an account, 79
- Delete messages, 84
- Empty trash, 85
- Receive emails, 83
- Remove an account, 82
- Send emails, 82
- Set up, 80

Messaging

- Add more to messages, 109
- Backup messages, 110
- Open Message View, 110
- Read unread messages, 107
- Reply to a message, 107
- Restore data, 111
- send messages to contacts, 107

Messaging Settings

- Auto-retrieve, 113
- Data Connection, 114
- Delivery reports (SMS), 113
- Read reports, 113
- Service Center, 115
- Signature, 115

MicroSD Card

- Installation, 16

MMS, 55**Music**

- Browse, 88
- Create a playlist, 89
- Manage playlist, 91

Music player, 92**N****Network Settings**

- Mobile settings, 65

Notes

- Add notes, 132
- Delete notes, 134
- Edit notes, 134
- Read notes, 133

P**Picture**

- Browse pictures, 98
- Crop a picture, 101
- Delete a picture, 100
- Rotate pictures, 99
- Share a picture, 102
- View slideshow, 99

Index

Picture settings

- Confirm deletions, 103
- Picture sort, 103
- Repeat slideshow, 103
- Shuffle slides, 103
- Slideshow interval, 103
- Slideshow transition, 103
- Thumbnail size, 103

Product overview, 20

R

Recorder, 106

S

Search

- Advanced search, 139
- Index statistic, 140
- Select search category, 139
- Simple search, 139

Status bar, 23

Stylus, 18

T

To Do List

- Create new tasks, 135
- Delete tasks, 136
- Edit tasks, 135

Touch screen

- Drag items, 26
- Scroll right/left, 26
- Scroll up/down, 26
- Selection, 25
- Zoom in, 26

V

Video

- Browse, 93
- delete a file, 94

- Delete multiple videos, 96
- Sort videos, 94
- Video player, 97
- View property, 96

W

World Clock

- Add clocks, 137
- Clock setting, 138
- Delete clocks, 137
- View clocks, 137